



Department for
Communities and
Local Government

Permitted development rights for householders

Technical Guidance



© Crown copyright, 2016

Copyright in the typographical arrangement rests with the Crown.

You may re-use this information (not including logos) free of charge in any format or medium, under the terms of the Open Government Licence. To view this licence, <http://www.nationalarchives.gov.uk/doc/open-government-licence/version/3/> or write to the Information Policy Team, The National Archives, Kew, London TW9 4DU, or email: psi@nationalarchives.gsi.gov.uk.

This document/publication is also available on our website at www.gov.uk/dclg

If you have any enquiries regarding this document/publication, complete the form at <http://forms.communities.gov.uk/> or write to us at:

Department for Communities and Local Government
Fry Building
2 Marsham Street
London
SW1P 4DF
Telephone: 030 3444 0000

For all our latest news and updates follow us on Twitter: <https://twitter.com/CommunitiesUK>

April 2016

ISBN: 978-1-4098-4824-0

Contents

Introduction	4
General issues	6
The structure of the rules on permitted development	8
Class A – enlargement, improvement or alteration	10
Class B – additions etc to the roof	33
Class C – other alterations to the roof	38
Class D - porches	40
Class E – buildings etc	41
Other Classes under Part 1	47
Class F – hard surfaces	47
Class G – chimney, flues etc	48
Class H – microwave antenna	49

Introduction

Permitted development rights allow householders to improve and extend their homes without the need to apply for planning permission where that would be out of proportion with the impact of works carried out. Larger single storey rear extensions are subject to a neighbour consultation scheme (see page 18). It is important that homeowners understand how they can exercise their rights to carry out development while protecting the interests of their neighbours and the wider environment. The Department for Communities and Local Government has produced this technical guidance to help them. It is designed to be used by anyone who wants to understand more about the detailed rules on permitted development and the terms used in those rules. However, anyone who has no previous knowledge of permitted development issues will find it useful to look at the Planning Practice Guidance first at:

<http://planningguidance.communities.gov.uk/blog/guidance/when-is-permission-required/>.

The guidance set out below gives an explanation of the rules on permitted development for householders, what these mean and how they should be applied in particular sets of circumstances. Diagrams have been included for illustrative purposes only and these are not drawn to scale. Given the very substantial variations in the design of individual houses, this guide cannot cover all possible situations that may arise. Where there is any doubt as to whether a development would be permitted development, advice should be sought from the local planning authority. To be certain that a proposed development is lawful and does not require an application for planning permission it is possible to apply for a 'Lawful Development Certificate' from the local authority. Further information on this can be found in the Planning Practice Guidance at:

<http://planningguidance.communities.gov.uk/blog/guidance/lawful-development-certificates/>.

Permitted development rights do not remove requirements for permissions or consents under other regimes such as the building regulations¹ and the Party Wall Act².

Householder permitted development rights are set out in the Town and Country Planning (General Permitted Development) (England) Order 2015 ("the Order") as amended by the Town and Country Planning (General Permitted Development) (England) (Amendment) Order 2016³. Part 1 of Schedule 2 to the Order sets out the permitted development rules concerning what enlargements, improvements, alterations and other additions a householder may make to their house and the area around it without the need for an application for planning permission. These rights do not apply to houses created through the permitted development rights to change use, set out in Classes M, N, P, PA⁴, and Q of Part 3 of Schedule 2 to the Order, from shops, premises offering financial and professional

¹ Information on building regulations can be found at <https://www.gov.uk/building-regulations-approval/when-you-need-approval>

² Guidance on the Party Wall etc. Act 1996 can be found at <https://www.gov.uk/party-wall-etc-act-1996-guidance>

³ The Order and subsequent amendment can be found at: <http://www.legislation.gov.uk/uksi/2015/596> and <http://www.legislation.gov.uk/uksi/2016/332/made>

⁴ Class PA allows change of use from light industrial use to a dwellinghouse from 1 October 2017 to 30 September 2020

services, betting shops, pay day loan shops, amusement arcades, casinos, launderettes, premises offering storage or distribution services, light industrial premises and agricultural buildings; or any houses which are flats. In these cases planning permission should be sought.

General issues

Some of the terms used are defined in the Order. These include:

“Article 2(3) land” - this includes land within a National Park, the Broads, an area of outstanding natural beauty, an area designated as a conservation area, and land within World Heritage Sites.

“Building” - includes any part of a building and includes any structure or erection, but does not include mechanical plant or machinery or gates, fences, walls, or other means of enclosure.

“Dwellinghouse” - does not include buildings containing one or more flats or a single flat contained within a building. (Note, however, that for the purposes of this guidance, the word “house” is used rather than “dwellinghouse” except where quoting the legislation directly.)

“Existing” - means a building as it existed immediately before the permitted development (for example a house extension) is undertaken. *The existing house will include previous development to the house, whether undertaken as permitted development or as development resulting from a planning permission from the local authority.*

“Height” - references to height (for example, the heights of the eaves on a house extension) is the height measured from ground level. (Note, ground level is the surface of the ground immediately adjacent to the building in question, and would not include any addition laid on top of the ground such as decking. Where ground level is not uniform (for example if the ground is sloping), then the ground level is the highest part of the surface of the ground next to the building.)

“Highway” – is a public right of way such as a public road, public footpath and bridleway. For the purposes of the Order it also includes unadopted streets or private ways.

“Original” - means a building as it existed on 1 July 1948 where it was built before that date, and as it was built if built after that date.

“Raised” - in relation to a platform means a platform with a height greater than 0.3 metres.

“Terrace house” - means a dwellinghouse situated in a row of 3 or more dwellinghouses used or designed for use as single dwellings, where

- (a) it shares a party wall with, or has a main wall adjoining the main wall of, the dwellinghouse on either side or
- (b) if it is at the end of a row, it shares a party wall with or has a main wall adjoining the main wall of a dwellinghouse which fulfils the requirements of subparagraph (a).

“Unadopted street” – means a street not being a highway maintainable at the public expense within the meaning of the Highways Act 1980.

Some terms used in this guidance are not defined in the Order but are understood as follows:

“Curtilage” - is land which forms part and parcel with the house. Usually it is the area of land within which the house sits, or to which it is attached, such as the garden, but for some houses, especially in the case of properties with large grounds, it may be a smaller area.

“Enlarged part of the house” - is the part(s) of a dwellinghouse comprising any enlargements of the original house, whether built under permitted development rights or following any application for planning permission, and whether the enlargement is undertaken on a single occasion or added incrementally.

“Principal elevation” – in most cases the principal elevation will be that part of the house which fronts (directly or at an angle) the main highway serving the house (the main highway will be the one that sets the postcode for the house concerned). It will usually contain the main architectural features such as main bay windows or a porch serving the main entrance to the house. Usually, but not exclusively, the principal elevation will be what is understood to be the front of the house.

There will only be one principal elevation on a house. Where there are two elevations which may have the character of a principal elevation, for example on a corner plot, a view will need to be taken as to which of these forms the principal elevation.

The structure of the rules on permitted development

The rules on permitted development, set out in Schedule 2 of the Order, are sub-divided into a series of Parts. Part 1 specifically deals with development within the curtilage of a house. Part 1 is then sub-divided into Classes covering various types of development:

Class A covers the enlargement, improvement or alterations to a house such as rear or side extensions as well as general alterations such as new windows and doors. From 30 May 2013 to 30 May 2019 a neighbour consultation scheme for larger rear extensions under Class A is required.

Class B covers additions or alterations to roofs which enlarge the house such as loft conversions involving dormer windows.

Class C covers other alterations to roofs such as re-roofing or the installation of roof lights/windows.

Class D covers the erection of a porch outside an external door.

Class E covers the provision of buildings and other development within the curtilage of the house.

Class F covers the provision of hard surfaces within the curtilage of the house such as driveways.

Class G covers the installation, alteration, or replacement of a chimney, flue or soil and vent pipe.

Class H covers the installation, alteration, or replacement of microwave antenna such as satellite dishes.

There are also other Parts of the rules that may be relevant to householders. For example Part 2 covers matters such as erection or construction of gates, fences and walls, exterior painting, charging points for electric vehicles and CCTVs. Part 14 covers the installation of domestic microgeneration equipment such as solar panels.

When considering whether a development proposal is permitted development, all of the relevant Parts of the rules and all the Classes within those Parts need to be taken into account. For example Part 1 Class A prevents the installation, alteration or replacement of a chimney, flue or soil and vent pipe from being permitted development because these works are specifically provided for in Class G subject to the rules set out under that Class. Similarly, changes to the roof of a house are not permitted development under Class A, but may be permitted development under Class B or C.

In order to be permitted development, a proposal must meet all the limitations and conditions under each Class relevant to the proposal. It is therefore essential that any proposed household development is considered in the context of the permitted development rules as a whole in order to determine whether it benefits from permitted development rights and therefore does not require an application for planning permission.

For example, where a proposed two storey extension at the rear of a house has a roof that joins onto the main roof of the original house, the works will need to meet the requirements of both Class A (which covers the enlargement of the house) and Class C (which covers any alterations to the roof) in order to be permitted development. If the works also include the creation of a dormer window to enlarge the roof space, either in the extension or the original roof space, then they would also need to meet the requirements of Class B.

Further restrictions on permitted development

It is important to note that a local planning authority is allowed to remove permitted development rights in some or all of its area by issuing what is known as an Article 4 Direction; or may have removed those rights on the original, or any subsequent, planning permission for the house. Where permitted development rights have been removed in either of these ways a planning application will be needed for development. Before undertaking any development, checks should be undertaken with the local planning authority to determine whether any such restrictions on permitted development have been made.

The remainder of this guidance provides further explanation about the detailed rules covering what improvements can be made to a house and its surroundings as permitted development. In particular, it provides more details on the limits (for example on size) and the conditions that will need to be complied with if development is to take place without the need for an application for planning permission. The guidance covers in detail Classes A-E of Part 1 of the rules which cover common development projects such as extensions, loft conversions, alterations to a roof, porches, and buildings on land surrounding the house. The rules for Classes F-H are included in this document for reference but detailed guidance on them is not included, although cross-references are included to other guidance published by the Department for Communities and Local Government.

Class A – enlargement, improvement or alteration

This provides permitted development rights for the enlargement, improvement or other alteration of a house.

Under Class A the following limits and conditions apply:

A.1 Development is not permitted by Class A if –

- (a) **permission to use the dwellinghouse as a dwellinghouse has been granted only by virtue of Class M, N, P, PA or Q of Part 2 of this Schedule (change of use)**

Enlargement etc. is not permitted where the house was created under the permitted development rights to change use, set out in Classes M, N, P, PA, and Q of Part 3 of Schedule 2 to the Order (see page 4).

- (b) **as a result of the works, the total area of ground covered by buildings within the curtilage of the dwellinghouse (other than the original dwellinghouse) would exceed 50% of the total area of the curtilage (excluding the ground area of the original dwellinghouse)**

Extensions (including any extensions to the original house under Class A or under a separate planning permission) and other buildings must not exceed 50% of the curtilage.

The 50% limit covers all buildings so will include existing and proposed outbuildings as well as any existing or proposed new extensions to a house. It will exclude the area covered by the original house but will include any later extensions or any separate detached buildings, even where they were built prior to 1948, or if the house was built after that date, built when the house itself was built (for example a detached garage or garden shed).

In the diagram below, the maximum area that can be built on as permitted development, whether as an extension to the house or outbuildings erected under Class E, would be 50% of the white area.

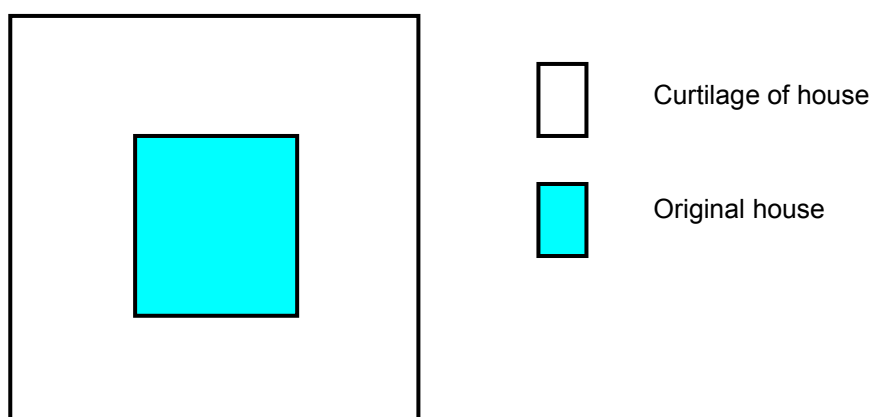

(c) the height of the part of the dwellinghouse enlarged, improved or altered would exceed the height of the highest part of the roof of the existing dwellinghouse

Any enlargement, improvement, or alteration to a house must not exceed the height of the highest part of the roof of the existing house. If it does, an application for planning permission will be required.

The highest part of the roof of the existing house will be the height of the ridge line of the main roof (even though there may be other ridge lines at a lower level) or the height of the highest roof where roofs on a building are flat.

Chimneys, firewalls, parapet walls and other protrusions above the main roof ridge line should not be taken into account when considering the height of the highest part of the roof of the existing house.

However, when calculating the height of the part of the house enlarged, this measurement should be at the highest part of the enlargement and may include any protrusions above the roof such as parapet walls etc.

(d) the height of the eaves of the part of the dwellinghouse enlarged, improved or altered would exceed the height of the eaves of the existing dwellinghouse

For the purpose of measuring height, the eaves of a house are the point where the lowest point of a roof slope, or a flat roof, meets the outside wall.

The height of the eaves will be measured from the ground level at the base of the external wall of the extension to the point where the external wall would meet (if projected upwards) the upper surface of the roof slope. Parapet walls and overhanging parts of eaves should not be included in any calculation of eaves height.

The following example shows the side view of an extension with a pitched roof:

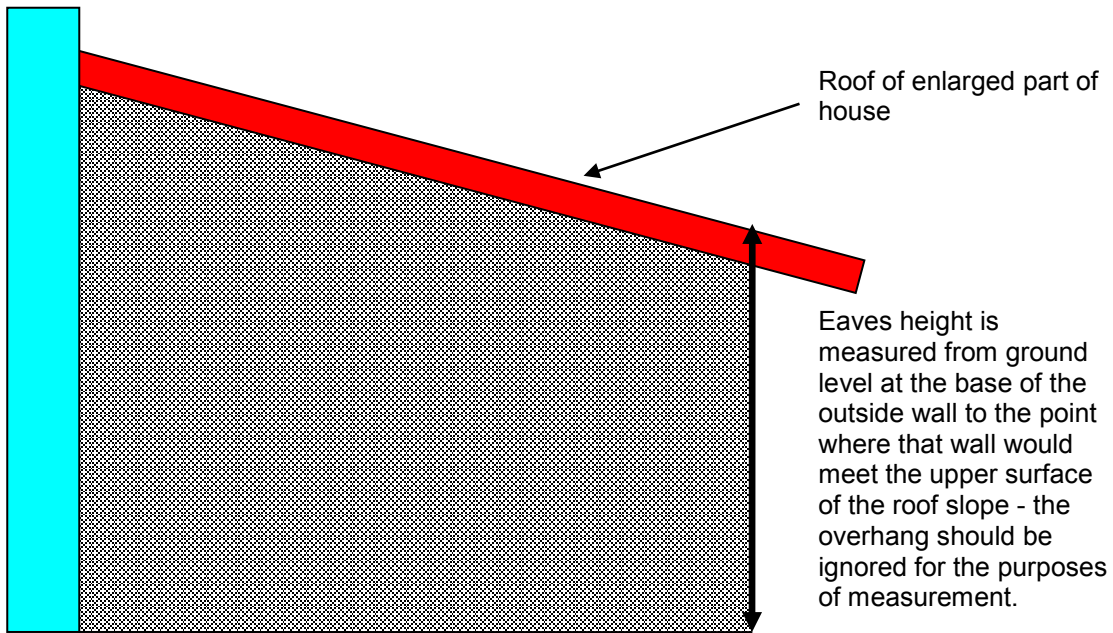

Where there is a flat roof, a similar approach should be taken for measuring eaves:

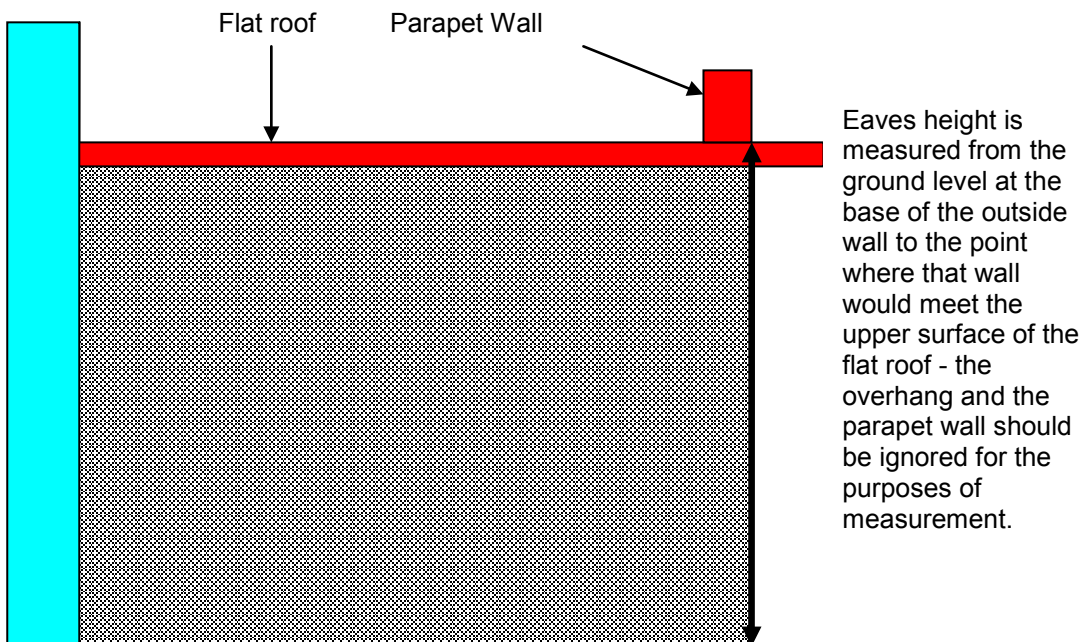

Where the existing house has eaves of different heights, then the restriction on the height of the eaves for the part of the house enlarged, improved or altered is measured against the highest level of eaves on the existing house. However, where a house is built on sloping ground, the height of the eaves on the existing house should be measured in terms of the elevation from which any extension of a house is to be made.

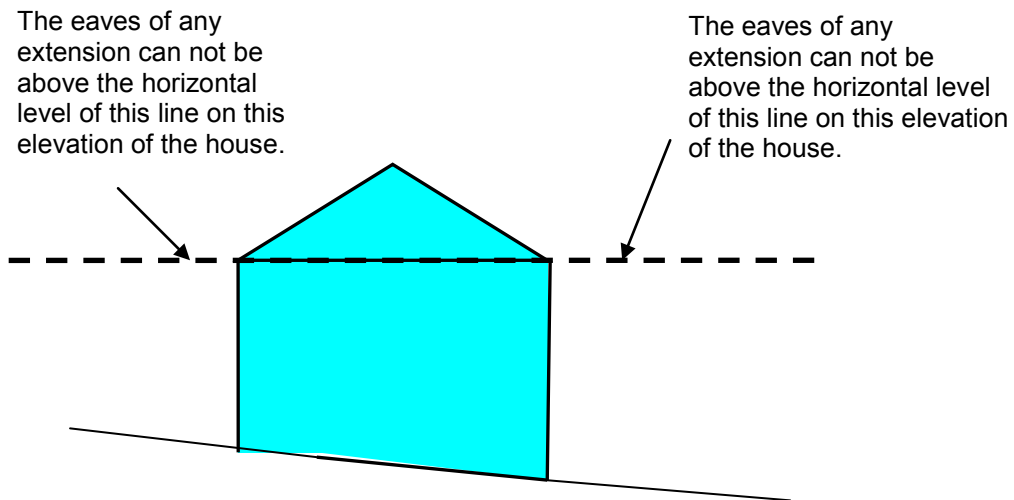

- (e) ***the enlarged part of the dwellinghouse would extend beyond a wall which -***
- (i) ***forms the principal elevation of the original dwellinghouse; or***
- (ii) ***fronts a highway and forms a side elevation of the original dwellinghouse***

This restriction means that any development to enlarge a house that is in front of a principal elevation, or in front of a side elevation that fronts a highway will require an application for planning permission. Principal elevation has the meaning set out in the 'General Issues' section of this document (see page 7).

In this context, 'extend beyond a wall' comprises not only the area immediately in front of the wall, but also an area in front of a line drawn from the end of the wall to the boundary of the property. In the diagram below, neither extension shown would be permitted development - they both extend beyond a wall forming a principal elevation that fronts a highway.

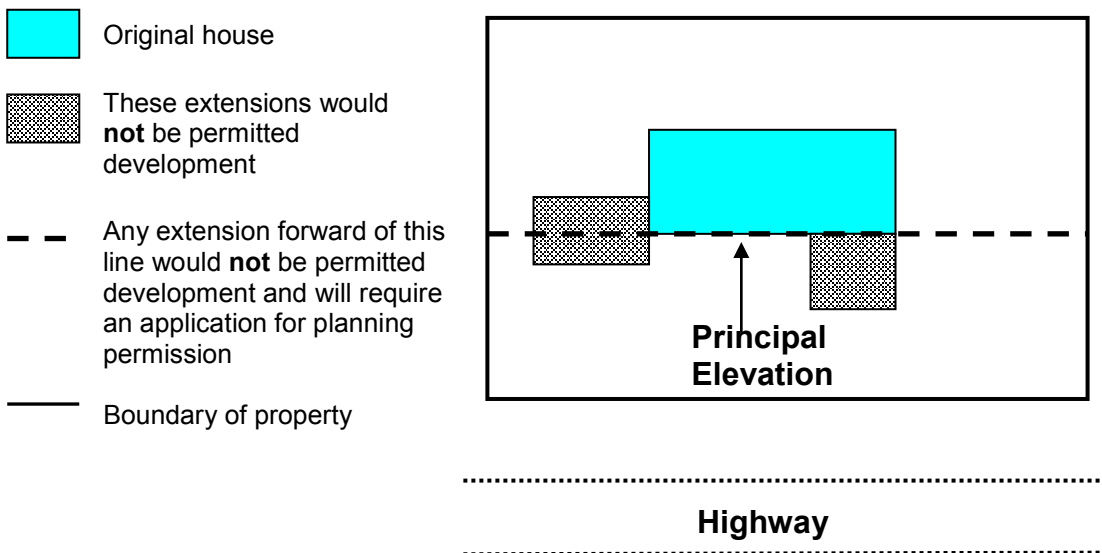

The principal elevation could include more than one wall facing in the same direction - for example, where there are large bay windows on the front elevation, or where there is an 'L' shaped frontage. In such cases, all such walls will form the principal elevation and the line for determining what constitutes 'extends beyond a wall' will follow these walls.

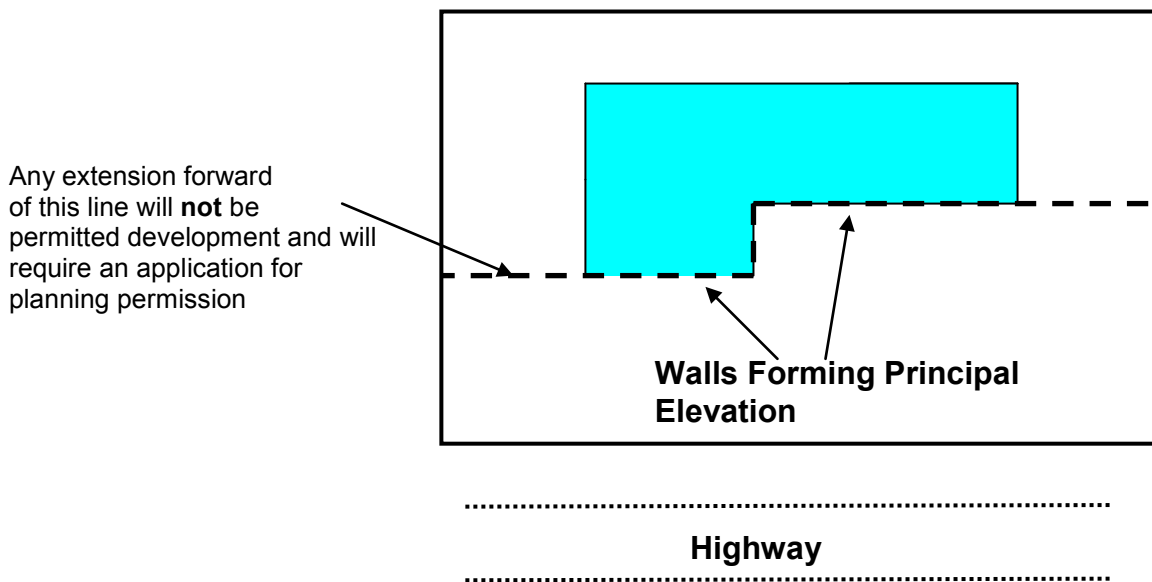
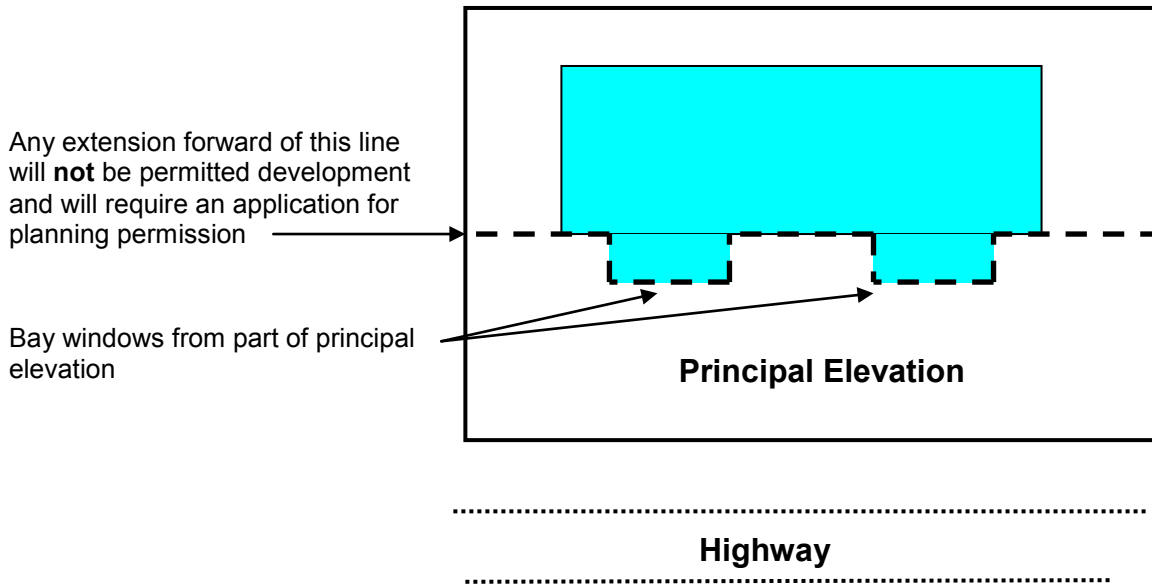

If a house sits on a corner plot where a side elevation fronts a highway, there will be an additional restriction on permitted development to the side of the house.

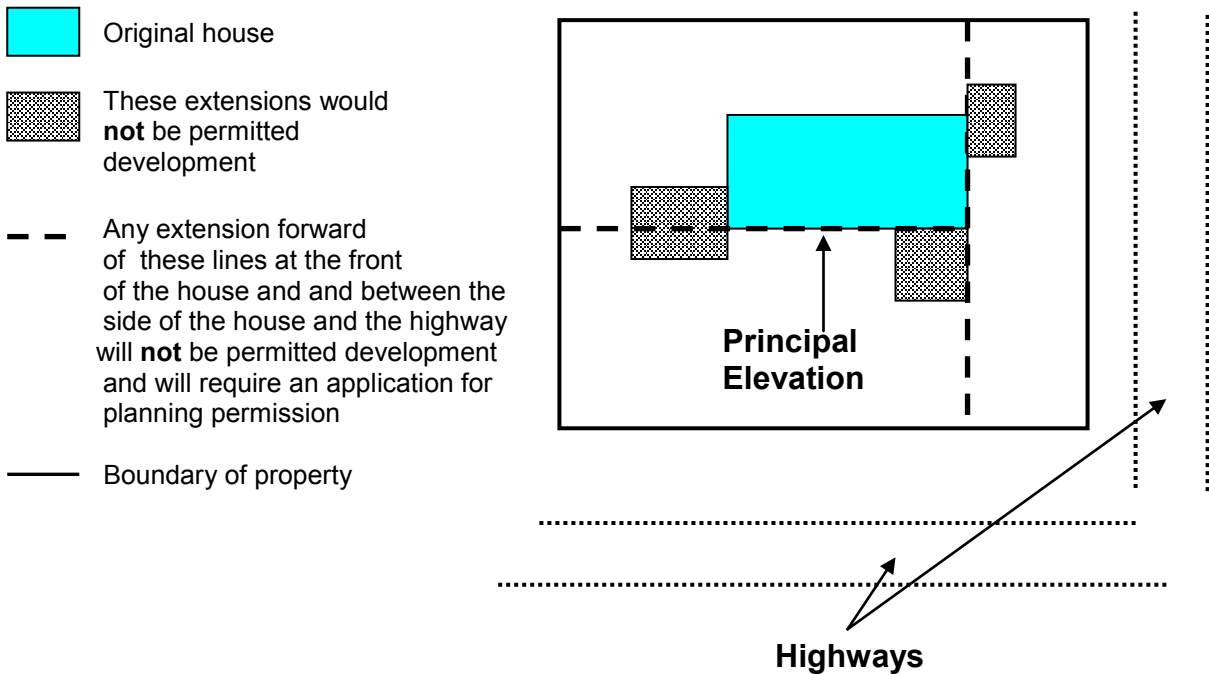

The extent to which an elevation of a house fronts a highway will depend on factors such as:

- (i) the angle between the elevation of the house and the highway. If that angle is more than 45 degrees, then the elevation will not normally be considered as fronting a highway;
- (ii) the distance between the house and the highway - in cases where that distance is substantial, it is unlikely that a building can be said to front the highway. The same may be true where there is a significant intervening area of land in different ownership or use between the boundary of the curtilage of the house concerned and the highway.

(f) the enlarged part of the dwellinghouse would have a single storey and -

- (i) extend beyond the rear wall of the original dwellinghouse by more than 4 metres in the case of a detached dwellinghouse, or 3 metres in the case of any other dwellinghouse, or**
- (ii) exceed 4 metres in height**

A single-storey extension must not extend beyond the rear of the original house by more than four metres if a detached house, or by more than three metres in any other case. In both cases, the total height of the extension must not be more than 4 metres. The rear wall or walls of a house will be those which are directly opposite the front of the house.

Measurement of the extension beyond the rear wall should be made from the base of the rear wall of the original house to the outer edge of the wall of the extension (not including any guttering or barge boards).

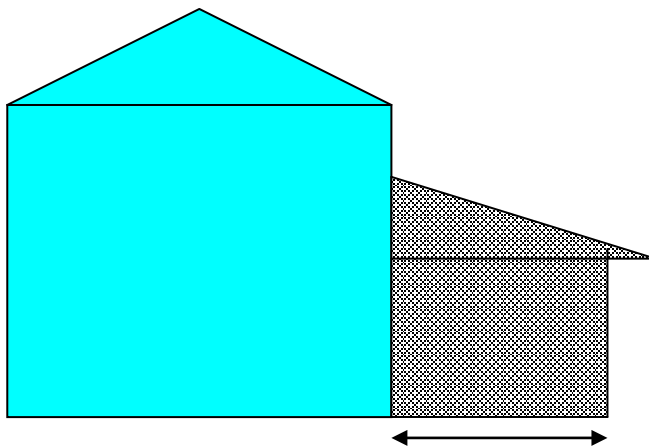

Measurement of 'extend beyond a rear wall' when the extension is directly attached to the rear wall

(g) until 30th May 2019, for a dwellinghouse not on article 2(3) land nor on a site of special scientific interest, the enlarged part of the dwellinghouse would have a single storey and -

- (i) extend beyond the rear wall of the original dwellinghouse by more than 8 metres in the case of a detached dwellinghouse, or 6 metres in the case of any other dwellinghouse, or***
- (ii) exceed 4 metres in height***

From 30 May 2013 until 30 May 2019 a single-storey extension can be larger than allowed under paragraph (f) above: it must not extend beyond the rear of the original house by more than 8 metres if a detached house, or by more than 6 metres in any other case. These larger extensions are not allowed for houses on article 2(3) land or on a site of special scientific interest. The height restriction remains the same: the extension must not be more than 4 metres high. The rear wall or walls of a house will be those which are directly opposite the front of the house. It remains the case that development is not permitted if, as a result of the works, the total area of ground covered by extensions and other buildings within the curtilage of the house would exceed 50% of the curtilage of the original house excluding the ground area of the original house (see paragraph (b) above).

These larger single-storey extensions, extending beyond the rear of the original house by more than 4 metres and less than 8 metres if a detached house, or by more than 3 metres and less than 6 metres in any other case, are subject to a neighbour consultation scheme for the impact of the proposed development on the amenity of their property. The requirements of the neighbour consultation scheme are set out in paragraph A.4 of Class A.

Householders wishing to build a larger extension have to notify the local planning authority about the proposed extension and the local planning authority must give adjoining neighbours notice of the proposals and the opportunity to object. Works cannot commence until the local planning authority notifies the householder that no prior approval is required, or gives prior approval, or 42 days have passed without any decision by the local planning authority. Works must be completed by 30 May 2019 and the local planning authority must be notified of their completion.

Single-storey extensions that do not extend beyond the rear of the original house by more than 4 metres if a detached house, or by more than 3 metres in any other case, (as set out in paragraph (f) above) are not subject to a neighbour consultation scheme.

Where the original rear wall of a house is stepped, then each of these walls will form 'the rear wall of the original dwellinghouse'. In such cases, the limits on extensions apply to any of the rear walls being extended beyond. In the example below showing a plan of a semi-detached house with an original 'stepped' rear, each of the extensions (shaded) would meet the requirements for a single storey extension as they do not extend more than 3 metres beyond the rear wall (or until 30 May 2019 more than 6 metres, except on article 2(3) land or sites of special scientific interest where the 3 metre limit remains in place).

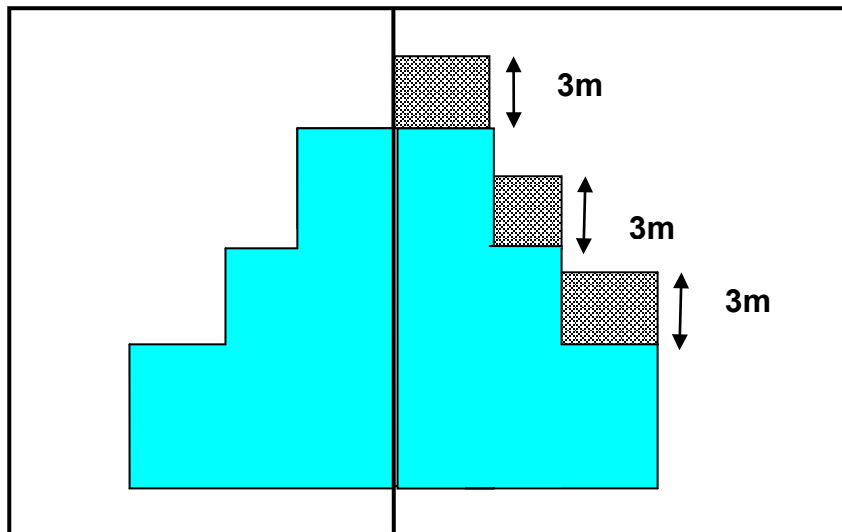

However, the extension shown below would not meet the requirements for permitted development. In the case of rear walls 'A' and 'B', the extension goes more than 3 metres beyond those walls (or until 30 May 2019 more than 6 metres, except on article 2(3) land or sites of special scientific interest where the 3 metre limit remains in place).

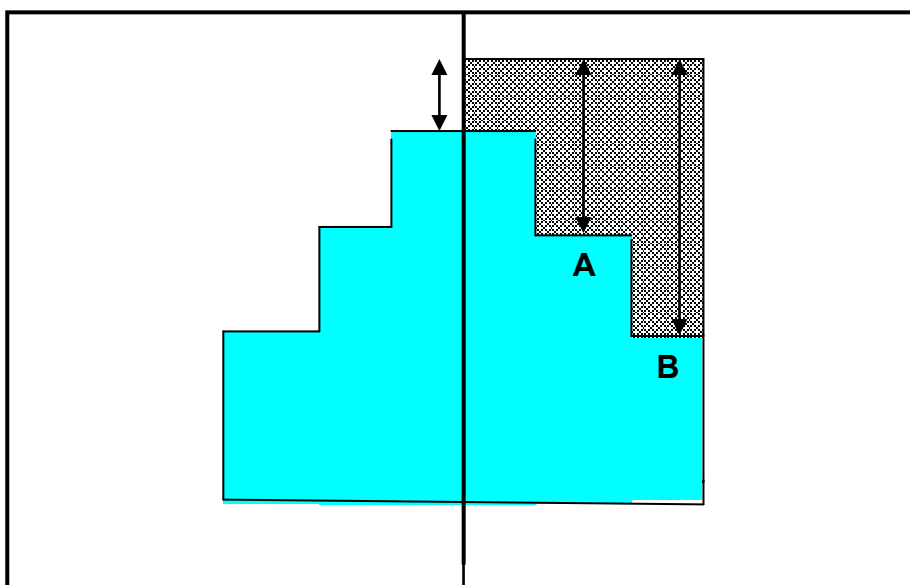

Side wall extensions extending beyond rear walls

An extension on a side wall that extends beyond a rear wall, but is not attached to a rear wall will be subject to the restrictions that apply to rear walls as well as the restrictions on side walls (these are covered under section (j) of the rules - see page 23). So in the example below, the extension is limited to three metres (or until 30 May 2019 6 metres, except on article 2(3) land or sites of special scientific interest where the 3 metre limit remains in place) beyond the rear wall of the semi-detached house as well as being restricted by the limits set for extensions from side walls.

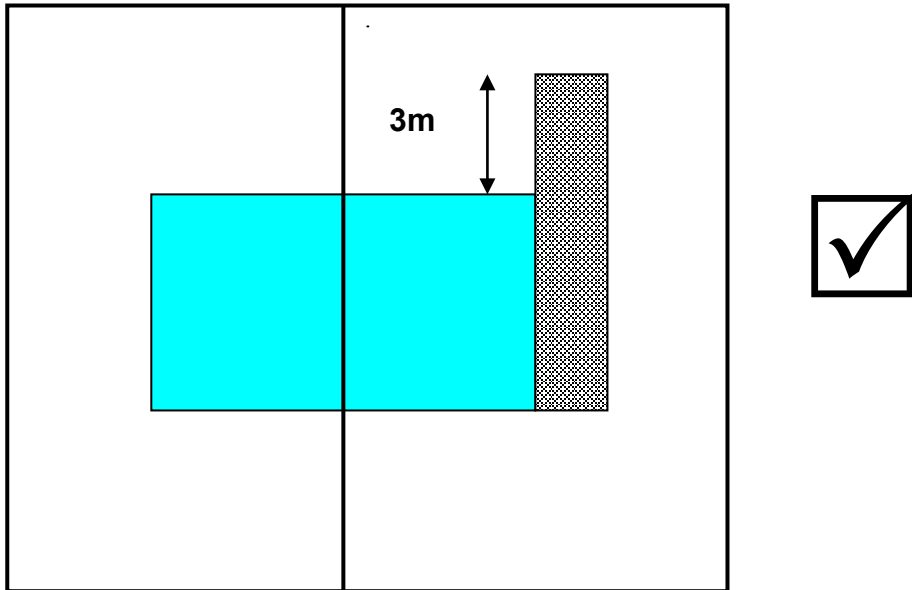

- h) the enlarged part of the dwellinghouse would have more than a single storey and -***
- (i) extend beyond the rear wall of the original dwellinghouse by more than 3 metres, or***
 - (ii) be within 7 metres of any boundary of the curtilage of the dwellinghouse being enlarged which is opposite the rear wall of that dwellinghouse***

The enlarged part of the house (see page 7) could be a two storey extension to a house, or might comprise the addition of a storey onto a part of the house which has already been enlarged through permitted development - for example, the addition of a second storey onto an existing single storey extension. The entire enlarged part of the house must not extend beyond the rear wall by more than 3 metres for the development to qualify as permitted development. Measurement of the extension beyond the rear wall should be made from the base of the rear wall of the original house that the enlargement extends beyond. Again, this limit applies to any rear wall being built out from (see diagrams under (g) above). Other limits in Class A also apply where relevant, for example the height limits in (c) and (d) above.

The limits applying to an enlargement of a house by more than one storey will apply in all cases where the enlarged part of the house includes any part that is of more than one storey. The following example, showing a side view of a detached house, would not be permitted development. If a detached house has an existing, single storey, ground floor extension that was not part of the original house, and which extended beyond the rear wall by more than 3 metres, then it would not be possible to add an additional first floor extension above this without an application for planning permission - because the enlarged part of the house would then consist of more than one storey and would extend beyond a rear wall by more than 3 metres.

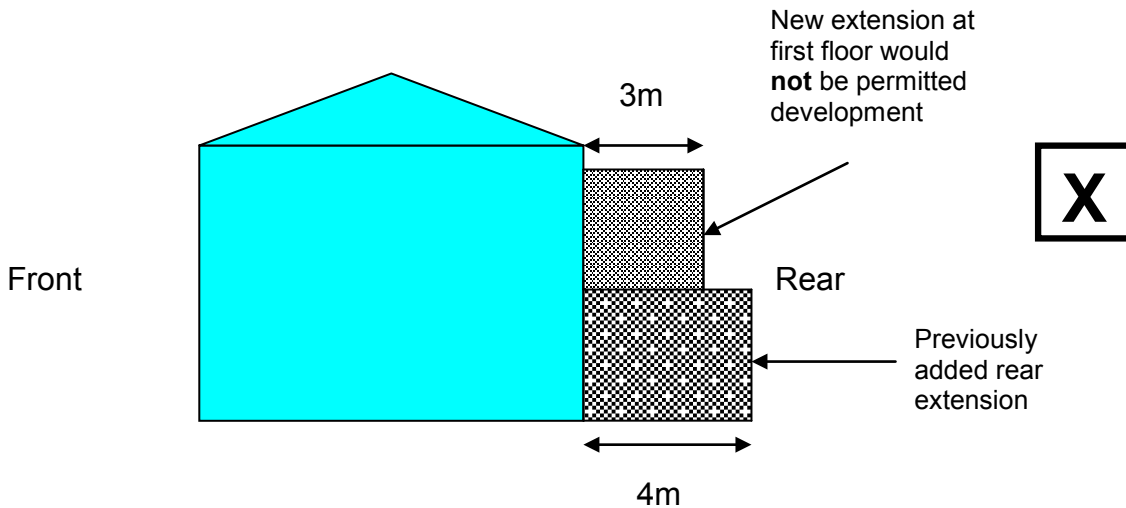

In addition, where the extension or enlarged part of the house has more than one storey, it must be a minimum of 7 metres away from any boundary of its curtilage which is opposite the rear wall of the house being enlarged. For example:

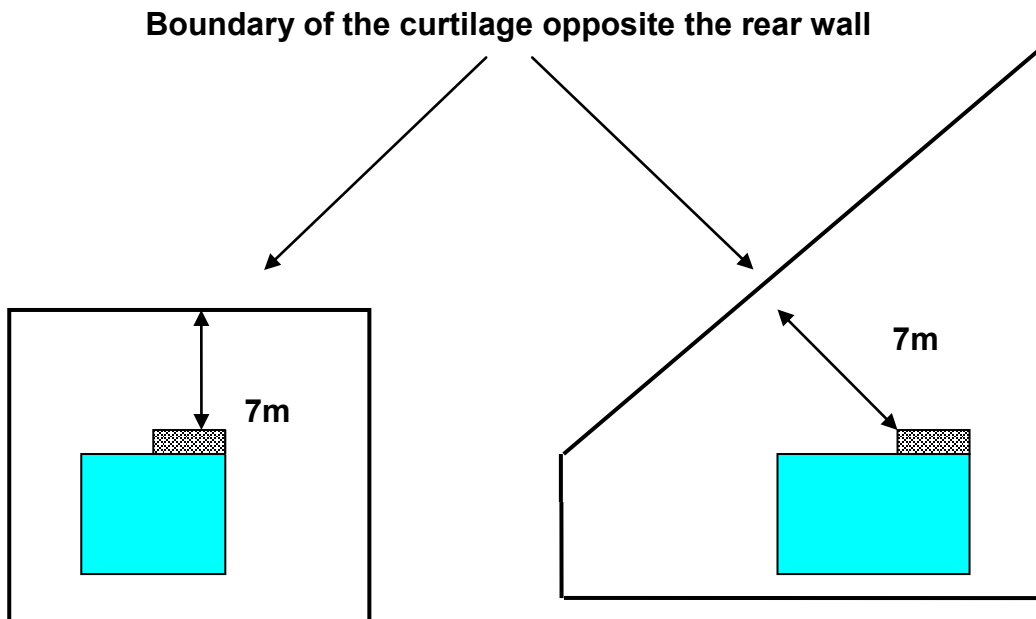

(i) the enlarged part of the dwellinghouse would be within 2 metres of the boundary of the curtilage of the dwellinghouse, and the height of the eaves of the enlarged part would exceed 3 metres

Where any part of a proposed extension to a house is within 2 metres of the boundary of its curtilage, then the maximum height of the eaves that is allowed for the proposal (or, if adding to an existing extension, the whole enlarged part), is 3 metres.

Guidance on measurement of height of eaves is covered under paragraph (d) above.

- (j) ***the enlarged part of the dwellinghouse would extend beyond a wall forming a side elevation of the original dwellinghouse, and would –***
- (i) ***exceed 4 metres in height,***
 - (ii) ***have more than a single storey, or***
 - (iii) ***have a width greater than half the width of the original dwellinghouse***

A wall forming a side elevation of a house will be any wall that cannot be identified as being a front wall or a rear wall. Houses will often have more than two side elevation walls. For example:

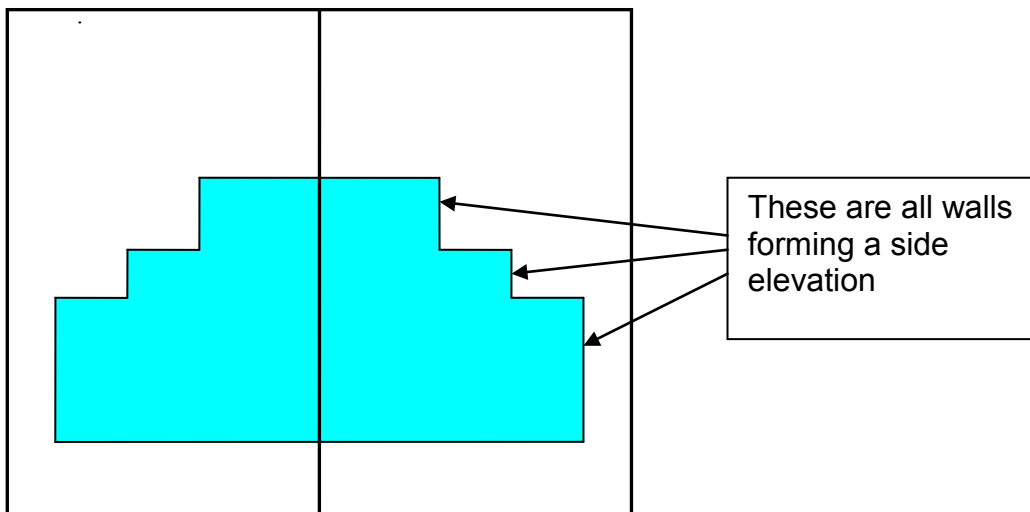

Where an extension is beyond any side wall, the restrictions in (j) will apply. Any extension can only be a single storey, must be less than 4 metres in height and can only be half the width of the original house. The width of the original house should be calculated at its widest point.

Rear and side extensions

Where an extension fills the area between a side elevation and a rear wall, then the restrictions on extensions beyond rear walls and side walls will both apply (see also page 20). The extension must:

- (i) extend no more than 3 metres beyond the rear wall, or no more than 4 metres in the case of a detached house (or until 30 May 2019 no more than 6 metres beyond the rear wall, or 8 metres for a detached house, except on article 2(3) land or sites of special scientific interest where the 3 and 4 metre limits remains in place),
- (ii) be a single storey and must not exceed 4 metres in height;
- (iii) have a total width that does not exceed more half the width of the house (measured at its widest point).

For example:

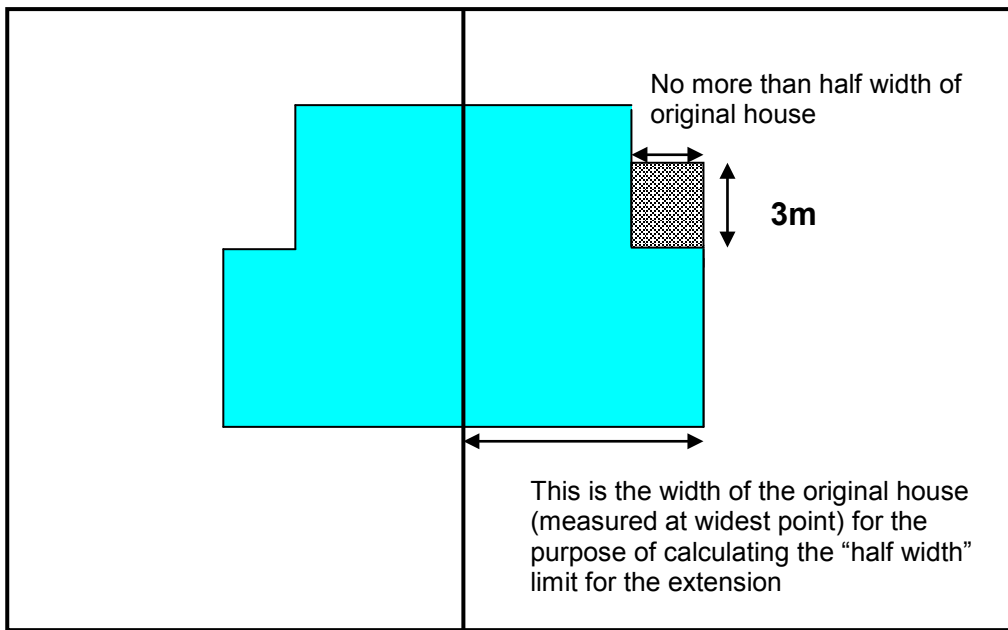

In the following example, although the extension is less than half the width of the original house and extends beyond the rear wall at 'A' by only 3 metres (or 6 metres until 30 May 2019, except on article 2(3) land or sites of special scientific where the 3 metre limit remains), it extends beyond the rear wall 'B' by more than 3 metres (or 6 metres until 30 May 2019, except on article 2(3) land or sites of special scientific where the 3 metre limit remains). It would therefore not be permitted development and will require an application for planning permission.

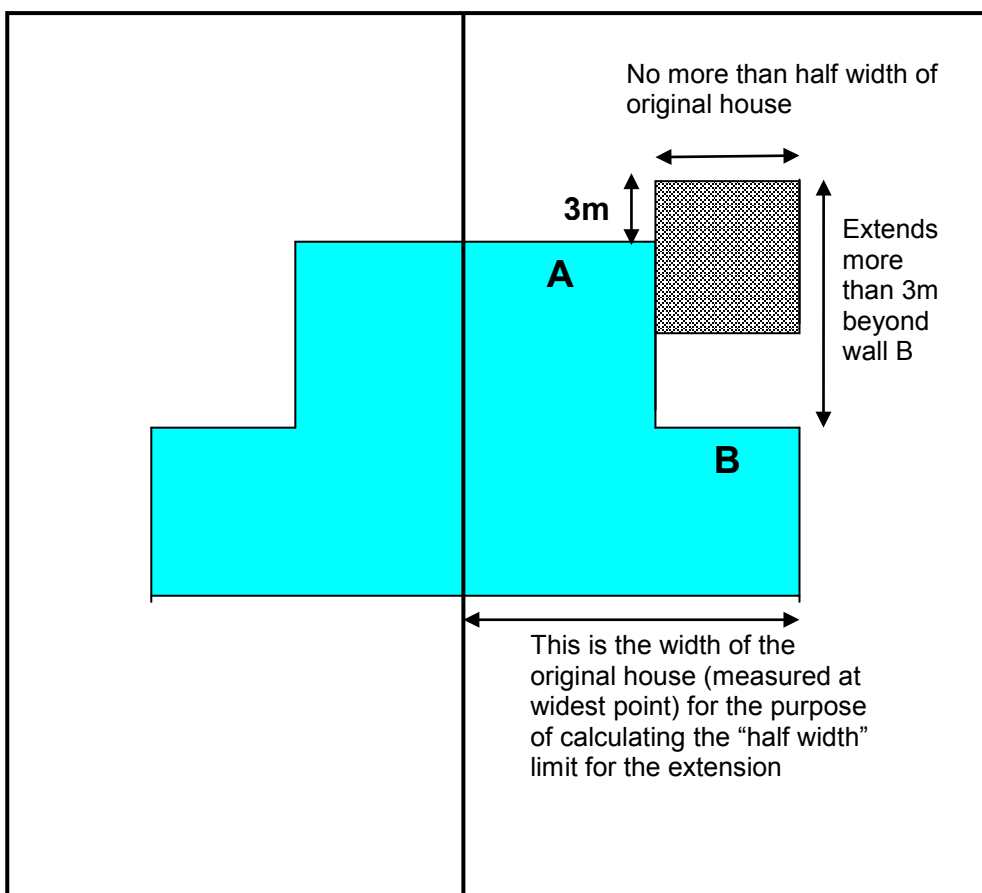

In other cases, an extension may comprise both elements of a rear and side extension. Examples could include:

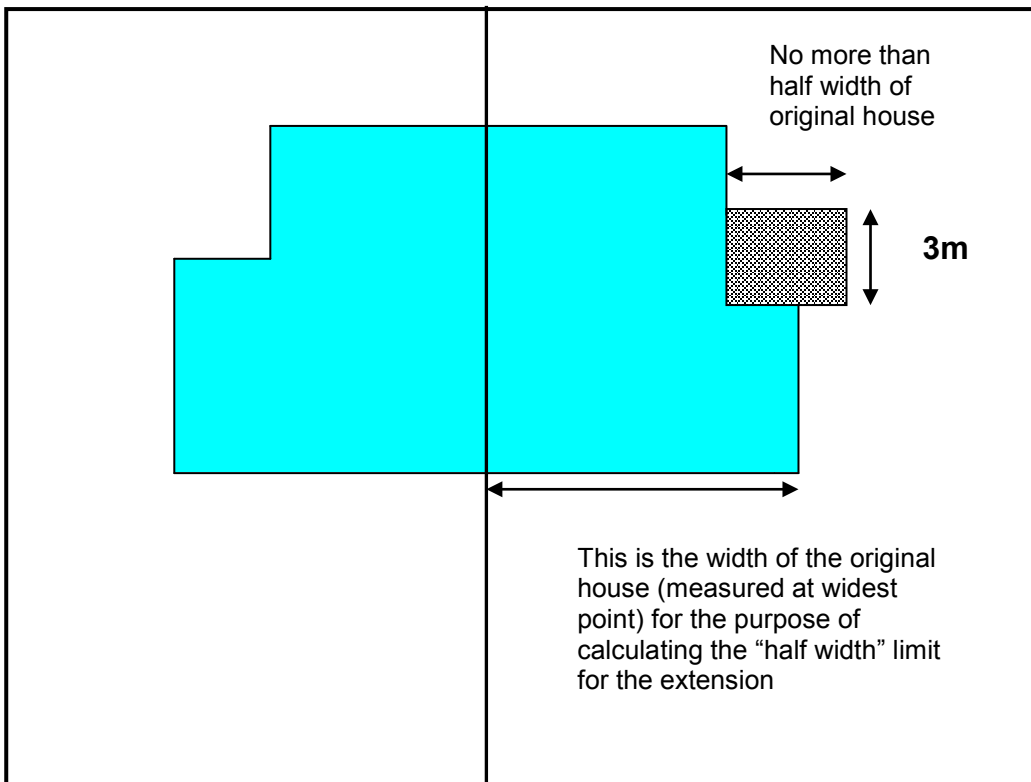
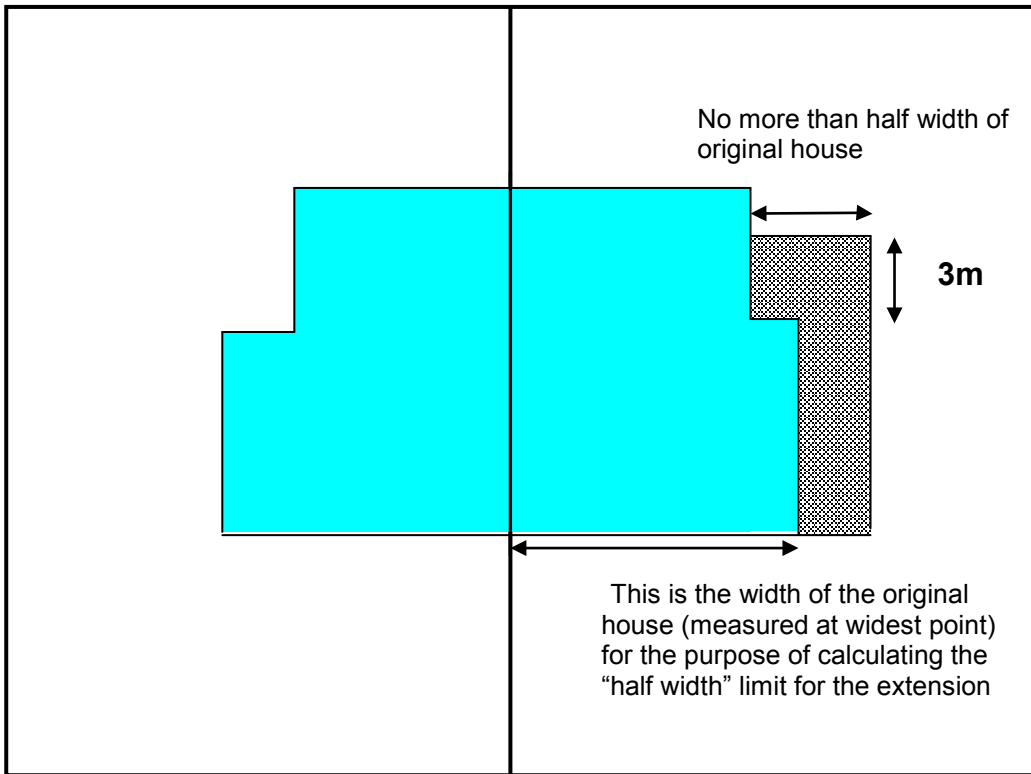

The following examples, however, would not be permitted development. In each case, the extension extends beyond a side wall and is more than half the width of the original house. An application for planning permission would therefore be required.

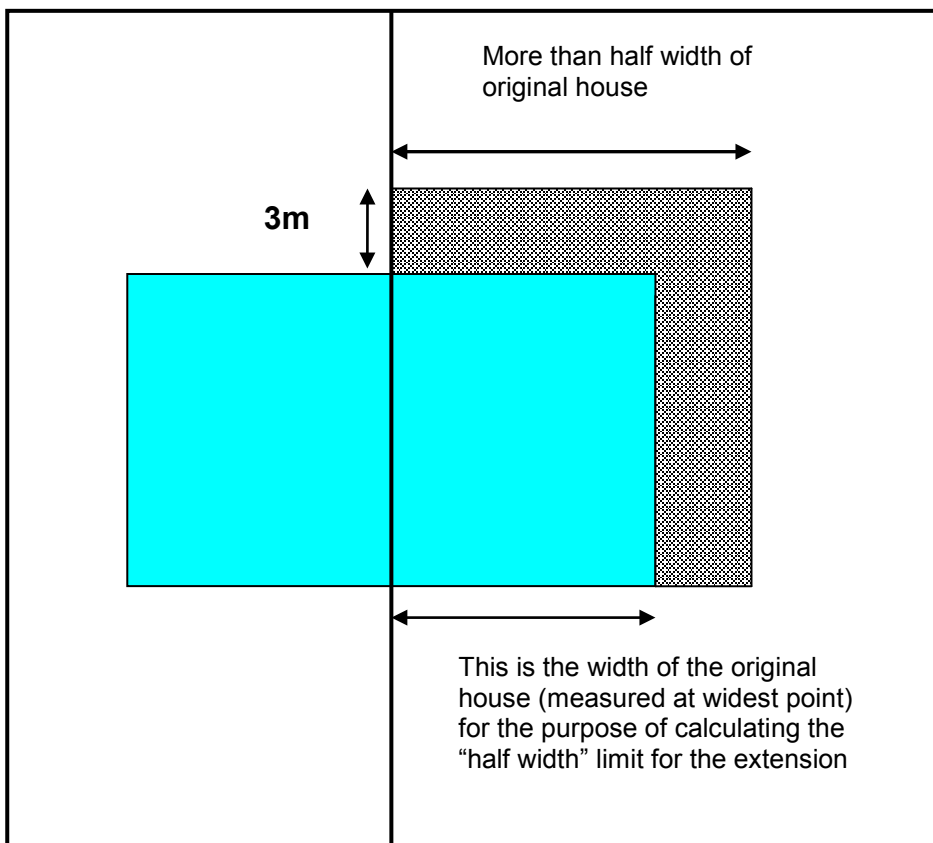
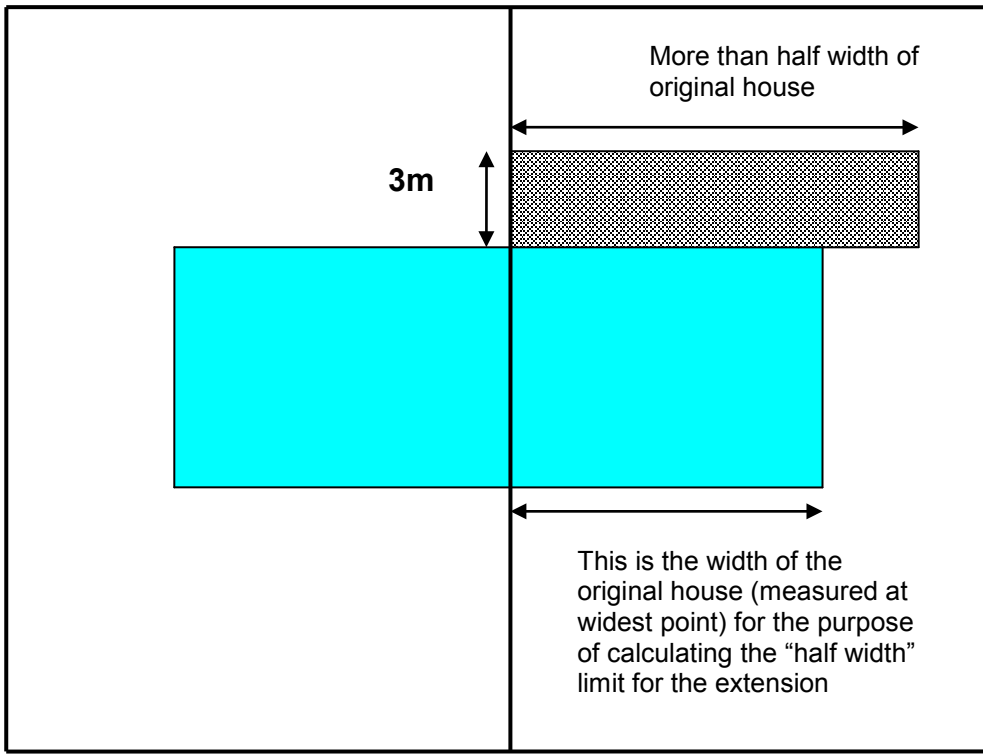

In some situations, it may be that development is undertaken in separate stages, for example, a side extension may be built first, and then a rear extension added at a later date. In this case, the whole of the enlarged part will be taken into account. For example:

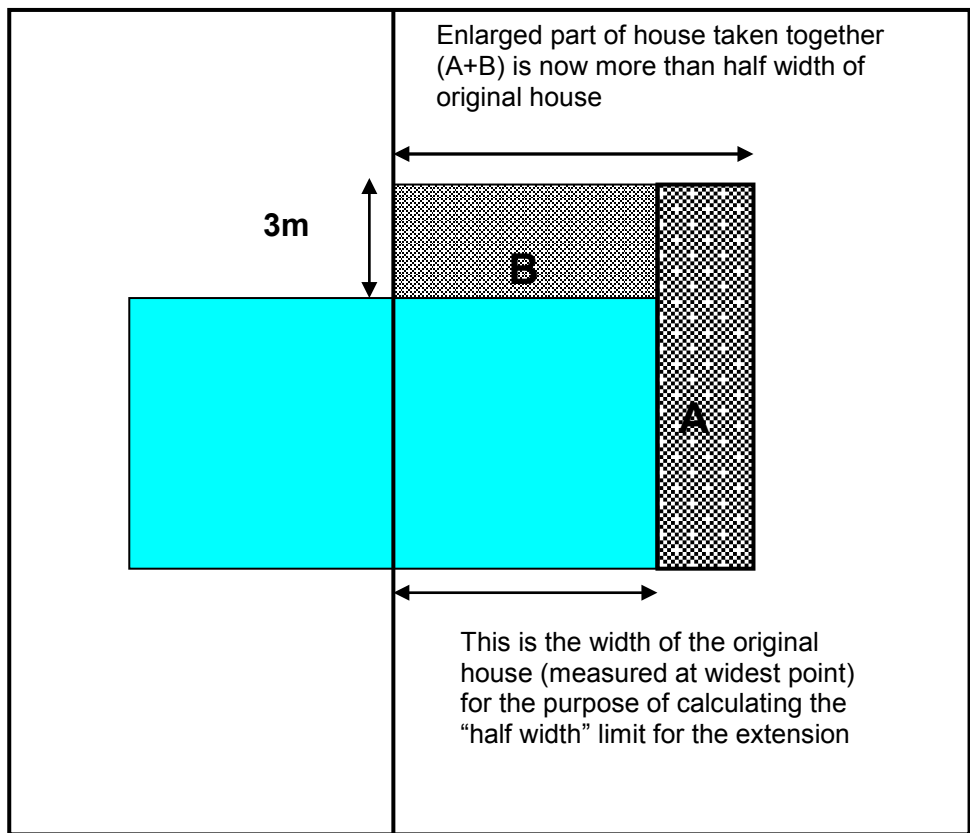

In the example above, if the side extension **A** was built first, it would meet the requirement for being no more than half of the width of the original house. However, the later addition of the rear extension **B** would mean that the total width of **A** + **B** at the widest point would be more than half the width of the house. The rear extension would therefore require an application for planning permission.

The next example would be permitted development. The original side extension **A** extends beyond a side wall by no more than half the width of the original house and would be permitted development (subject to meeting the other rules that are relevant under Class A). If the rear extension **B** is added at a later date, it has no effect on the width of the side extension (it does not join it). The enlarged part of the house therefore continues to be less than half the width of the house and therefore permitted development.

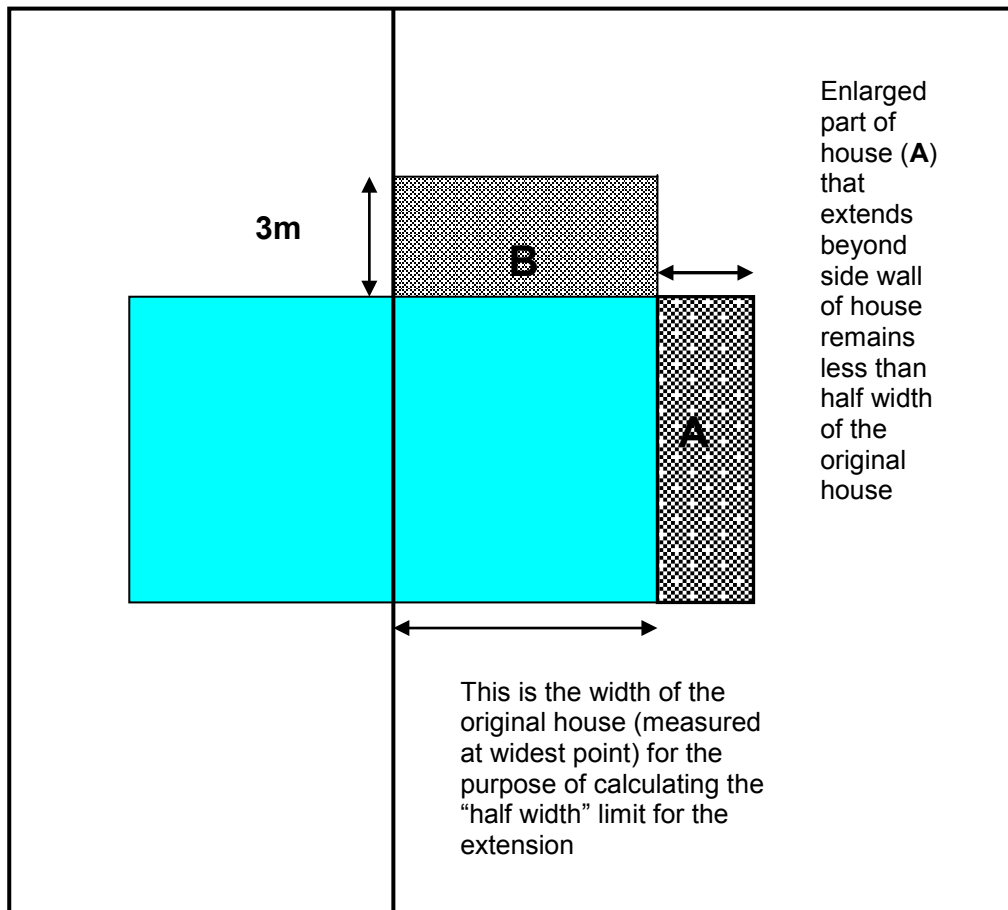

or

(k) it would consist of or include -

- (i) the construction or provision of a verandah, balcony or raised platform,**
- (ii) the installation, alteration or replacement of a microwave antenna,**
- (iii) the installation, alteration or replacement of a chimney, flue or soil and vent pipe, or**
- (iv) an alteration to any part of the roof of the dwellinghouse**

Verandahs, balconies and raised platforms are not permitted development and will require planning permission.

A veranda is understood to be a gallery, platform, or balcony, usually roofed and often partly enclosed, extending along the outside of a building at ground level.

A balcony is understood to be a platform with a rail, balustrade or parapet projecting outside an upper storey of a building. A 'Juliet' balcony, where there is no platform and therefore no external access, would normally be permitted development.

A raised platform is any platform with a height greater than 0.3 metres and will include roof terraces.

Although the items set out in (i), (ii), (iii) and (iv) are not permitted development under Class A of the rules, some may be permitted development under other Classes subject to the limitations and conditions set out in those classes:

- Class B covers enlargement of houses through alterations or additions to the roof and Class C covers other alterations to the roof of a house.
- Where an extension to a house under Class A includes works that would require an alteration to the existing roof of the house (for example where the roof of the extension joins the existing roof), the alterations to the existing roof of the house will need to meet the requirements of Class B or C (as appropriate) in order to be permitted development.
- Class E covers provision of a 'building' within the area around the house required for a purpose incidental to the enjoyment of the house but restricts the height of raised platforms. A 'Building' - includes any structure or erection – so Class E allows garden decking provided it is not more than 0.3 metres high.
- Class G covers the installation, alteration or replacement of a chimney, flue or soil and vent pipe.
- Class H covers the installation, alteration or replacement of a microwave antenna.

A.2 *In the case of a dwellinghouse on article 2(3) land, development is not permitted by Class A if -*

- (a) *it would consist of or include the cladding of any part of the exterior of the dwellinghouse with stone, artificial stone, pebble dash, render, timber, plastic or tiles;***
- (b) *the enlarged part of the dwellinghouse would extend beyond a wall forming a side elevation of the original dwellinghouse; or***
- (c) *the enlarged part of the dwellinghouse would have more than a single storey and extend beyond the rear wall of the original dwellinghouse***

This section of the rules sets out additional restrictions for National Parks, the Broads, areas of outstanding natural beauty, conservation areas, and land within World Heritage Sites. In these areas:

- the cladding of any part of a house, whether it be the original house or any enlarged part is not permitted development and requires an application for planning permission
- extensions beyond any side wall are not permitted development in these areas
- an extension from a rear wall is not permitted development if it results in an enlarged area of the house that has more than one storey.

Conditions

A.3 *Development is permitted by Class A subject to the following conditions-*

- (a) *the materials used in any exterior work (other than materials used in the construction of a conservatory) shall be of a similar appearance to those used in the construction of the exterior of the existing dwellinghouse***

The condition above is intended to ensure that any works to enlarge, alter or improve a house result in an appearance that minimises visual impact and is sympathetic to existing development. This means that the materials used should be of similar visual appearance to those in the existing house, but does not mean that they need to be the same materials. For example:

- the external walls of an extension should be constructed of materials that provide a similar visual appearance - for example in terms of colour and style of brick used - to the materials used in existing house walls
- a pitched roof on an extension should be clad in tiles that give a similar visual appearance to those used on the existing house roof. Again, colour and style will be important considerations; flat roofs will not normally have any visual impact and

so, where this is the case, the need for materials of similar appearance should not apply

- it may be appropriate to replace existing windows with new uPVC double-glazed windows or include them in an extension even if there are no such windows in the existing house. What is important is that they give a similar visual appearance to those in the existing house, for example in terms of their overall shape, and the colour and size of the frames.

The requirement for similar visual appearance does not apply to conservatories.

- b) any upper-floor window located in a wall or roof slope forming a side elevation of the dwellinghouse shall be -**
- (i) obscure-glazed, and**
- (ii) non-opening unless the parts of the window which can be opened are more than 1.7 metres above the floor of the room in which the window is installed**

This condition requires upper-floor windows in any part of the side of a house to be obscure glazed. Glazing to provide privacy is normally rated on a scale of 1-5, with 5 providing the most privacy. To be permitted development, side windows should be obscure glazed to minimum of level 3. Obscure glazing does not include one-way glass.

Where such a window is on a staircase or landing (i.e. not in a room) the 1.7 metre measurement should be made from the stair or point on a landing immediately below the centre of the window, upwards to the opening part of the window.

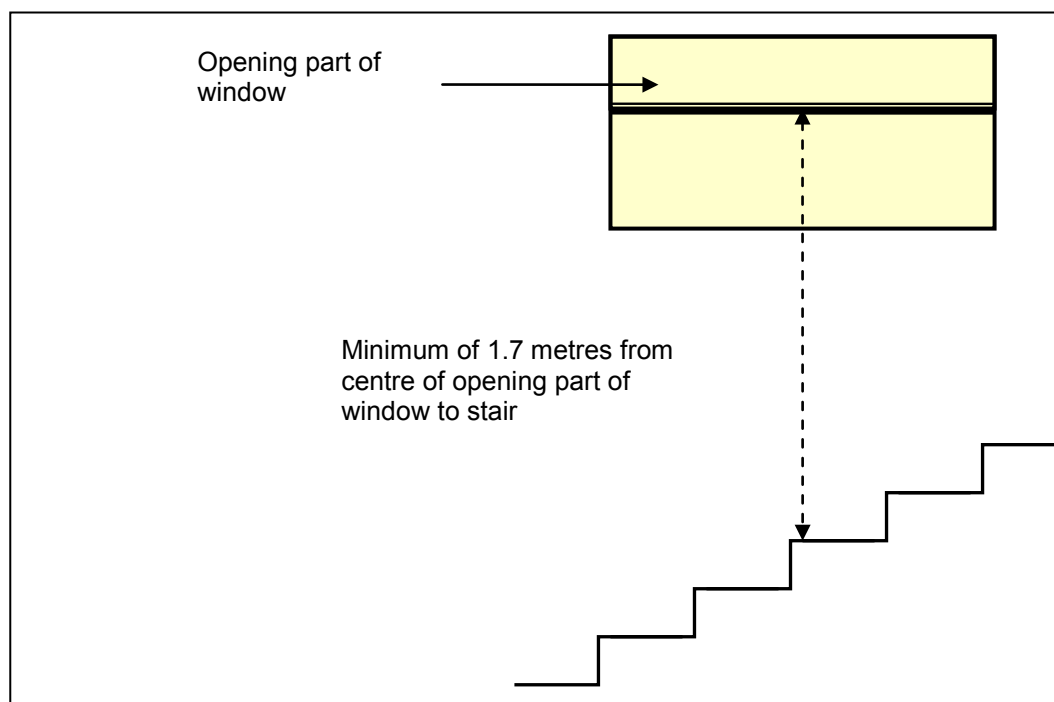

(c) where the enlarged part of the dwellinghouse has more than a single storey, the roof pitch of the enlarged part shall, so far as practicable, be the same as the roof pitch of the original dwellinghouse

For example:

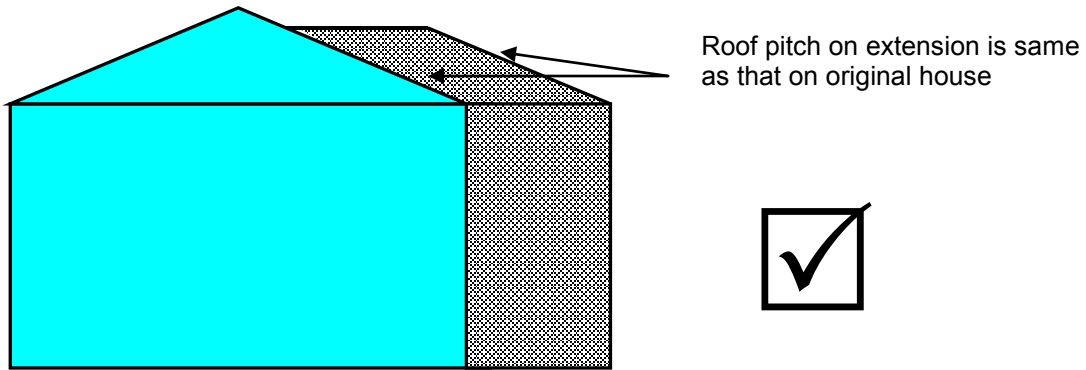

Solid Wall Installation

The installation of solid wall insulation constitutes an improvement rather than an enlargement or extension to the house and is not caught by the provisions of (e), (f), (g), (h) and (j).

Class B – additions etc to the roof

This provides permitted development rights for the enlargement of a house consisting of an addition or alteration to its roof.

Under Class B the following limits and conditions apply:

B.1 Development is not permitted by Class B if –

- a) permission to use the dwellinghouse as a dwellinghouse has been granted only by virtue of Class M, N, P, PA or Q of Part 2 of this Schedule (change of use)**

Enlargement is not permitted where the house was created under the permitted development rights to change use, set out in Classes M, N, P, PA, and Q of Part 3 of Schedule 2 to the Order (see page 4).

- (b) any part of the dwellinghouse would, as a result of the works, exceed the height of the highest part of the existing roof**

Additions and alterations made to a roof to enlarge a house (for example a loft conversion or the replacement of an existing flat roof with a pitched roof) will only be permitted development if no part of the house once enlarged exceeds the height of the highest part of the roof of the existing house. If it does, planning permission will be required.

The highest part of the roof of the existing house will be the height of the ridge line of the main roof (even though there may be other ridge lines at a lower level) or the height of the highest roof where roofs on a building are flat.

Chimneys, firewalls, parapet walls and other protrusions above the main roof ridge line should not be taken into account when considering the height of the highest part of the roof of the existing house.

- (c) any part of the dwellinghouse would, as a result of the works, extend beyond the plane of any existing roof slope which forms the principal elevation of the dwellinghouse and fronts a highway**

The effect of this is that dormer windows as part of a loft conversion, or any other enlargement of the roof space, are not permitted development on a principal elevation that fronts a highway and will therefore require an application for planning permission. Roof-lights in a loft conversion on a principal elevation may however be permitted development as long as they meet the requirements set out under Class C (see page 38). Principal elevation has the meaning set out in the 'General Issues' section of this document (see page 7).

The principal elevation could include more than one roof slope facing in the same direction. For example, where there are large bay windows on the front elevation, or where there is an 'L' shaped frontage. In such cases, all such roof slopes will form the

principal elevation and the line for determining what constitutes 'extends beyond the plane of any existing roof slope' will follow these slopes (see guidance on Class A (e) for an illustration of this on page 15).

The extent to which an elevation of a house fronts a highway will depend on factors such as those set out in relation to Class A (e) (see page 16).

(d) the cubic content of the resulting roof space would exceed the cubic content of the original roof space by more than -

(i) 40 cubic metres in the case of a terrace house, or

(ii) 50 cubic metres in any other case

For the purposes of Class B "resulting roof space" means the roof space as enlarged, taking into account any enlargement to the original roof space, whether permitted by this Class or not.

To be permitted development any additional roof space created must not increase the volume of the original roof space of the house by more than 40 cubic metres for terraced houses and 50 cubic metres for semi-detached and detached houses. Any previous enlargement to the original roof space in any part of the house must be included in this volume allowance. 'Terrace house' has the meaning set out in the 'General Issues' section of this document (see page 6).

'Original roof space' will be that roof space in the 'original building' (see 'General Issues' on page 6 for the definition of this).

(e) it would consist of or include -

(i) the construction or provision of a verandah, balcony or raised platform, or

(ii) the installation, alteration or replacement of a chimney, flue or soil and vent pipe

Alterations to the roof of a house for loft conversions involving the creation of balconies are not permitted development and will require planning permission. 'Balcony' can be understood as set out on page 29.

Installation, alteration or replacement of chimneys, flues or soil and vent pipes will often be necessary when loft conversions are undertaken. Whilst these are not permitted development under Class B of these rules, they may be permitted development under Class G.

(f) the dwellinghouse is on article 2(3) land

In National Parks, the Broads, areas of outstanding natural beauty, conservation areas, and land within World Heritage Sites, roof extensions are not permitted development and will require an application for planning permission.

Conditions

B.2 Development is permitted by Class B subject to the following conditions -

- (a) the materials used in any exterior work shall be of a similar appearance to those used in the construction of the exterior of the existing dwellinghouse***

This condition is intended to ensure that any addition or alteration to a roof for a loft conversion results in an appearance that minimises visual impact and is sympathetic to the existing house. This means that the materials used should be of similar visual appearance to those in the existing house, but does not mean that they need to be the same materials or match exactly. The visual impacts of the materials used will be the most important consideration. For example:

- the flat roofs of dormer windows will not normally have any visual impact and so, in this case, the use of materials such as felt, lead or zinc for flat roofs of dormers will therefore be acceptable
- the face and sides of a dormer window should be finished using materials that give a similar visual appearance to existing house. So the materials used for facing a dormer should appear to be of similar colour and design to the materials used in the main roof of the house when viewed from ground level. Window frames should also be similar to those in the existing house in terms of their colour and overall shape.

- (b) the enlargement shall be constructed so that –***

(i) other than in the case of a hip-to-gable enlargement or an enlargement which joins the original roof to the roof of a rear or side extension –

(aa) the eaves of the original roof are maintained or reinstated; and

(bb) the edge of the enlargement closest to the eaves of the original roof shall, so far as practicable, be not less than 0.2 metres from the eaves, measured along the roof slope from the outside edge of the eaves; and

(ii) other than in the case of an enlargement which joins the original roof to the roof of a rear or side extension, no part of the enlargement extends beyond the outside face of any external wall of the original dwellinghouse

It is sometimes necessary to remove the eaves of the original roof while works are carried out. To be permitted development eaves that are temporarily removed should be reinstated.

The measurement of 0.2 metres should be made along the original roof slope from the outermost edge of the eaves (the edge of the tiles or slates) to the edge of the enlargement. Any guttering that protrudes beyond the roof slope should not be included in this measurement.

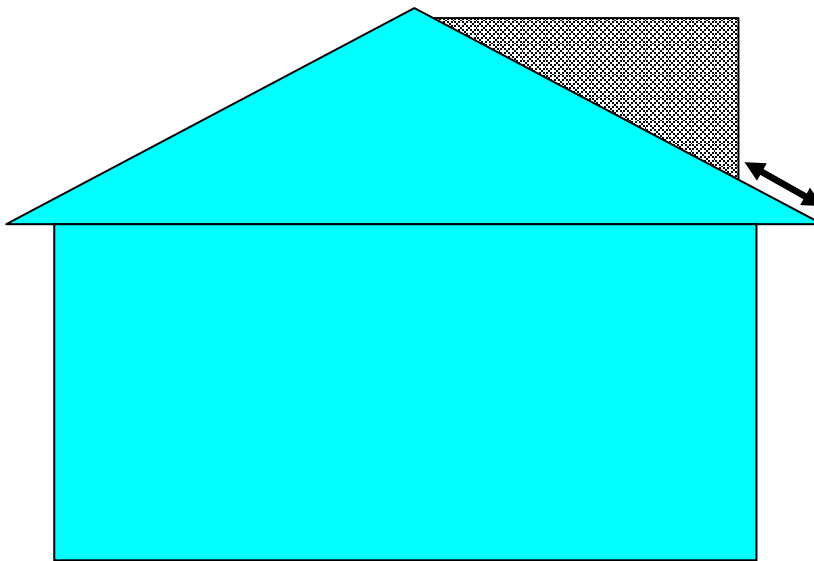

Minimum of 0.2m from eaves to edge of the enlargement to be measured along the roof slope from the edge of the enlargement to the outer edge of the eaves. The enlargement cannot overhang the outer face of the wall of the original house.

This 0.2m set back will be required unless it can be demonstrated that this is not possible due to practical or structural considerations. One circumstance where it will not prove practical to maintain this 0.2m distance will be where a dormer on a side extension of a house joins an existing, or proposed, dormer on the main roof of the house.

The enlarged part of the roof must not extend beyond the outer face of any wall of the original house if it is to qualify as permitted development, unless it joins the original roof to the roof of a rear or side extension. An interpretative provision at paragraph B.4 of Class B clarifies that for these purposes any roof tiles, guttering, fascias, barge boards or other minor roof details which overhang the outer face of the wall should not to be considered part of the roof enlargement.

The enlarged part of the roof may join the original roof to the roof of a rear or side extension (generally referred to as an 'L-shaped dormer' on a main roof and 'outrigger' or 'back addition' roof), whether the part of the house being extended forms part of the original house or is an enlargement, or the shape or level of the pitch of the roofs are different in relation to each other.

(c) any window inserted on a wall or roof slope forming a side elevation of the dwellinghouse shall be -

(i) obscure-glazed, and

(ii) non-opening unless the parts of the window which can be opened are more than 1.7 metres above the floor of the room in which the window is installed

Windows for a loft extension on a side elevation of a house must be obscure glazed to benefit from permitted development. Glazing to provide privacy is normally rated on a scale of 1-5, with 5 providing the most privacy. To be permitted development, side

windows should be obscure glazed to minimum of level 3. Obscure glazed does not include one-way glass.

Where such a window is on a staircase or landing (ie not in a room) the 1.7 metres measurement should be made from the stair or point on a landing immediately below the centre of the window, upwards to the opening part of the window (see diagram under Class A - A.3 (b) above).

Class C – other alterations to the roof

This provides permitted development rights for any other alteration to the roof of a house.

Such alterations will not involve any enlargement of the house, but would, for example, cover the installation of roof lights/windows.

Under Class C the following limits and conditions apply:

C.1 Development is not permitted by Class C if –

- a) ***permission to use the dwellinghouse as a dwellinghouse has been granted only by virtue of Class M, N, P, PA or Q of Part 2 of this Schedule (change of use)***

Alterations are not permitted where the house was created under the permitted development rights to change use, set out in Classes M, N, P, PA, and Q of Part 3 of Schedule 2 to the Order (see page 4).

- (b) ***the alteration would protrude more than 0.15 metres beyond the plane of the slope of the original roof when measured from the perpendicular with the external surface of the original roof***

Any protrusion from a roof, for example, for a roof light/window and its frame, will be limited to 0.15m:

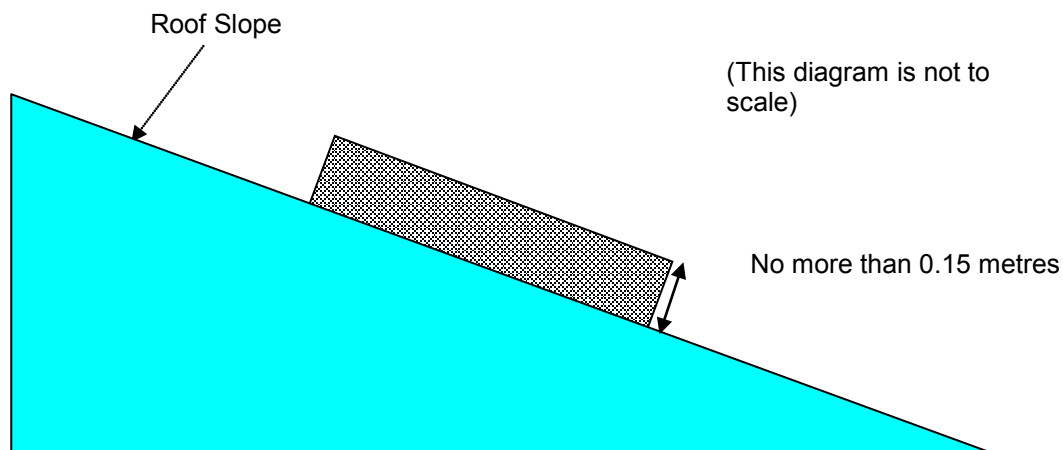

This limitation to projection from the roof plane should not be applied in cases where the roof of an extension to a house that is permitted development under Class A is joined to the roof of the original house. In such cases, the roof of the extension should not be considered under Class C as protruding from the original roof.

(c) it would result in the highest part of the alteration being higher than the highest part of the original roof; or

(d) it would consist of or include-

(i) the installation, alteration or replacement of a chimney, flue or soil and vent pipe, or

Guidance on these limits is covered under Class B above and will also apply to development under Class C. Note, however, that in the case of Class C, measurement of height is made against the original roof and not as in Class B where it is the existing roof. 'Original' and 'existing' are defined in the 'General Issues' section of this guidance (see page 6).

(ii) the installation, alteration or replacement of solar photovoltaics or solar thermal equipment

Although solar photovoltaics and solar thermal equipment (i.e. solar panels) are not permitted development under Class C, they may not require an application for planning permission if they meet the requirements set out under Part 14 of the rules on permitted development.

Conditions

C.2 Development is permitted by Class C subject to the condition that any window located on a roof slope forming a side elevation of the dwellinghouse shall be -

(a) obscure-glazed; and

(b) non-opening unless the parts of the window which can be opened are more than 1.7 metres above the floor of the room in which the window is installed

Guidance on these conditions is covered under Class B above and will also apply to development under Class C.

Class D - porches

This provides permitted development rights for the erection of a porch outside any external door of a house.

D1. Development is not permitted by Class D if –

- (a) permission to use the dwellinghouse as a dwellinghouse has been granted only by virtue of Class M, N, P, PA or Q of Part 2 of this Schedule (change of use)***

The erection of a porch is not permitted where the house was created under the permitted development rights to change use, set out in Classes M, N, P, PA, and Q of Part 3 of Schedule 2 to the Order (see page 4).

- (b) the ground area (measured externally) of the structure would exceed 3 square metres***
- (c) any part of the structure would be more than 3 metres above ground level or***
- (d) any part of the structure would be within 2 metres of any boundary of the curtilage of the dwellinghouse with a highway***

Class E – buildings etc

This provides permitted development rights within the curtilage of a house for:

- (a) ***any building or enclosure, swimming or other pool required for a purpose incidental to the enjoyment of the dwellinghouse as such, or the maintenance, improvement or other alteration of such a building or enclosure or***
- (b) ***a container used for domestic heating purposes for the storage of oil or liquid petroleum gas***

Class E sets out the rules on permitted development for buildings etc within the curtilage (see page 7) of a house. Buildings which are attached to the house are not permitted under Class E (they would be subject to the rules in Class A). Buildings under Class E should be built for purposes incidental to the enjoyment of the house. Paragraph E.4 of Class E indicates that purposes incidental to the enjoyment of the house includes the keeping of poultry, bees, pet animals, birds or other livestock for the domestic needs or personal enjoyment of the occupants of the house.

But the rules also allow, subject to the conditions and limitations below, a large range of other buildings on land surrounding a house. Examples could include common buildings such as garden sheds, other storage buildings, garages, and garden decking as long as they can be properly be described as having a purpose incidental to the enjoyment of the house. A purpose incidental to a house would not, however, cover normal residential uses, such as separate self-contained accommodation nor the use of an outbuilding for primary living accommodation such as a bedroom, bathroom, or kitchen.

Under Class E, the following limits and conditions apply:

E.1 Development is not permitted by Class E if –

- a) ***permission to use the dwellinghouse as a dwellinghouse has been granted only by virtue of Class M, N, P, PA or Q of Part 2 of this Schedule (change of use)***

Buildings etc are not permitted where the house was created under the permitted development rights to change use, set out in Classes M, N, P, PA, and Q of Part 3 of Schedule 2 to the Order (see page 4)

- (b) ***the total area of ground covered by buildings, enclosures and containers within the curtilage (other than the original dwellinghouse) would exceed 50% of the total area of the curtilage (excluding the ground area of the original dwellinghouse)***

The total area of ground around the house covered by buildings, enclosures and containers must not exceed 50% of the total area of the curtilage, excluding the original house (see pages 6 and 7). The 50% limit covers all buildings, so will include any existing

or proposed new extensions to the original house under Class A of the permitted development rules or that have been granted planning permission, as well as existing and proposed outbuildings. It will exclude the area covered by the original house, but will include any separate detached buildings even where they were built prior to 1948 or if the house was built after that date, built when the house itself was built (for example a detached garage).

(c) any part of the building, enclosure, pool or container would be situated on land forward of a wall forming the principal elevation of the original dwellinghouse

Development is not permitted under Class E in any area in front of the principal elevation of a house. It also prevents permitted development anywhere in front of a hypothetical line drawn through the principal elevation to the side boundary of the land surrounding the house. Principal elevation has the meaning set out in the 'General Issues' section of this document (see page 7). For example:

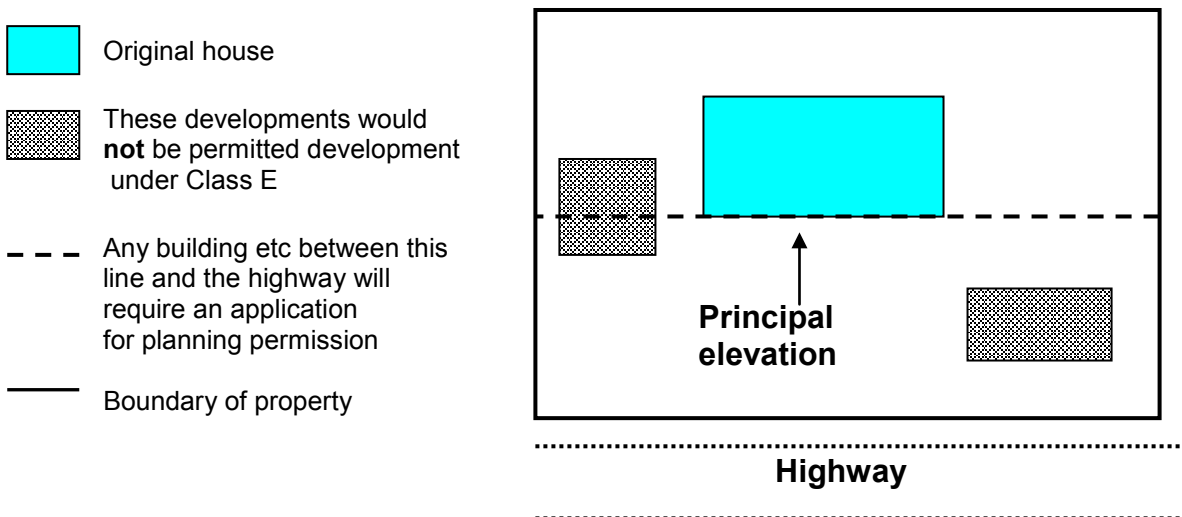

Where the principal elevation comprises more than one wall facing in the same direction, all such walls will form part of the principal elevation and the line for determining what constitutes 'extends beyond a wall' will follow these walls:

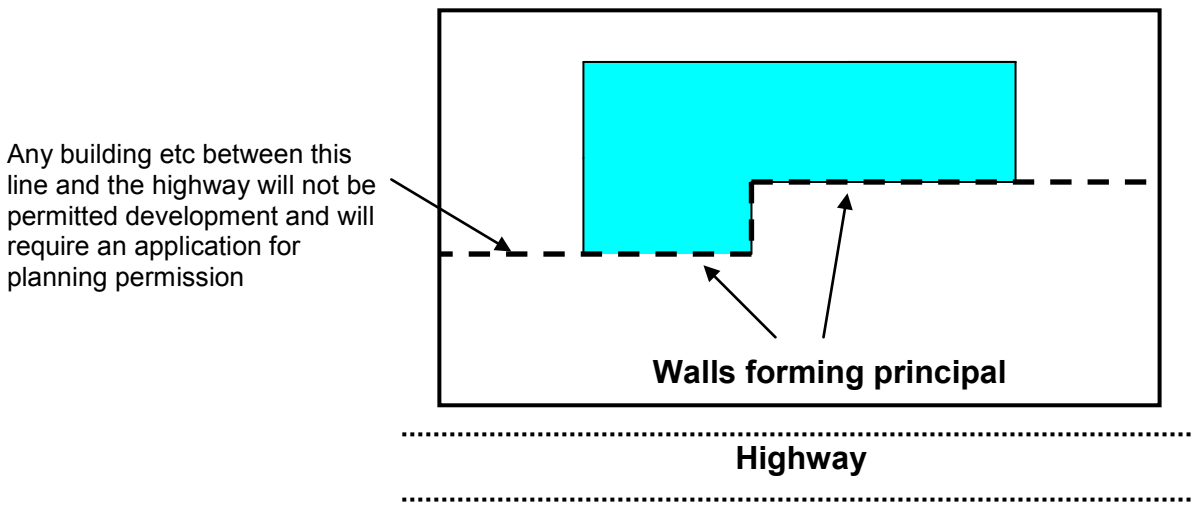

(d) the building would have more than a single storey

Any buildings within the curtilage can only have one storey. Buildings with more than one storey are not permitted development and will require an application for planning permission.

(e) the height of the building, enclosure or container would exceed -

- (i) 4 metres in the case of a building with a dual-pitched roof,**
- (ii) 2.5 metres in the case of a building, enclosure or container within 2 metres of the boundary of the curtilage of the dwellinghouse, or**
- (iii) 3 metres in any other case**

The height of the building, enclosure or container should be measured from the highest ground level immediately adjacent to the building, enclosure, or container to its highest point.

The height limit on a 'dual-pitched roof' of four metres should also be applied to buildings that have 'hipped' roofs (slopes on all four sides).

If any part of the building, container or enclosure is within two metres of the boundary of the curtilage of the house, then the height limit for the whole development is restricted to 2.5 metres if it is to be permitted development.

(f) the height of the eaves of the building would exceed 2.5 metres

The eaves of a building will be the point where the lowest point of a roof slope, or a flat roof, meets the outside wall of the building. The Guidance on Class A (d) above includes examples and further guidance (see page 12).

Under Class E the maximum height of the eaves on any part of the building (irrespective of total height) is 2.5 metres. For example, on a building with a single-pitched roof, the 2.5 metres eaves limit and three metres maximum height limit would be as shown below.

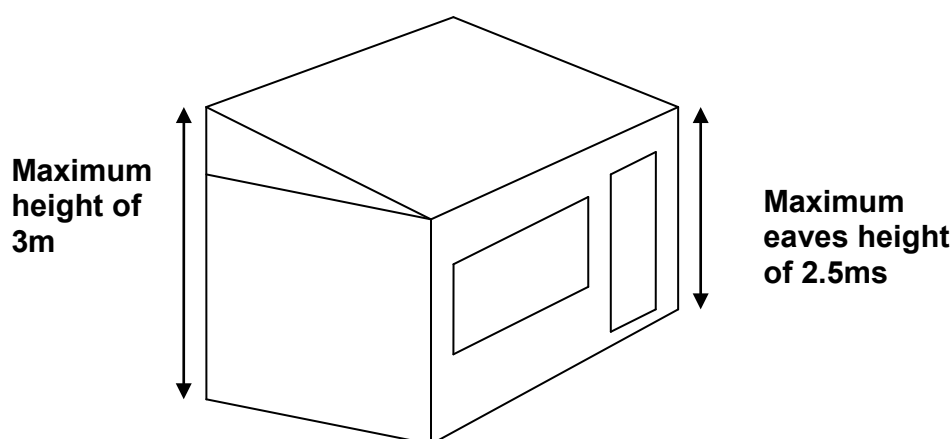

- (g) the building, enclosure, pool or container would be situated within the curtilage of a listed building**

An application for planning permission will be required for any building, enclosure, pool or container that would be situated on land surrounding a listed building.

- (h) it would include the construction or provision of a verandah, balcony or raised platform**

Verandahs, balconies and raised platforms are not permitted development under Class E.

‘Verandah’ and balcony’ can be understood as set out on page 29. A raised platform is defined as any platform that has a height of more than 0.3 metres (see page 6). Garden decking will therefore be permitted development under Class E subject to it not exceeding this 0.3m height limit and subject to the other limits and conditions under this Class.

- (i) it relates to a dwelling or a microwave antenna**

Class E covers buildings that are for a purpose incidental to a house. Class E does not provide permitted development rights for works related to a house (for example, extensions to a house) which are covered by other Classes of the rules on permitted development. Permitted development rights for microwave antenna are covered under Class H of the rules.

- (j) the capacity of the container would exceed 3,500 litres.**

A container with a capacity greater than 3,500 litres will not be permitted development and will require an application for planning permission.

E.2 In the case of any land within the curtilage of the dwellinghouse which is within -

- (a) a World Heritage Site,**
- (b) a National Park, ,**
- (c) an area of outstanding natural beauty or**
- (d) the Broads,**

development is not permitted by Class E if the total area of ground covered by buildings, enclosures, pools and containers situated more than 20 metres from any wall of the dwellinghouse would exceed 10 square metres

The effect of this limitation is to restrict the amount of permitted development for buildings, enclosures, pools and containers located more than 20 metres away from any wall of the house. The total area of ground which may be covered by buildings etc more than 20 metres from any wall of a house is 10 square metres.

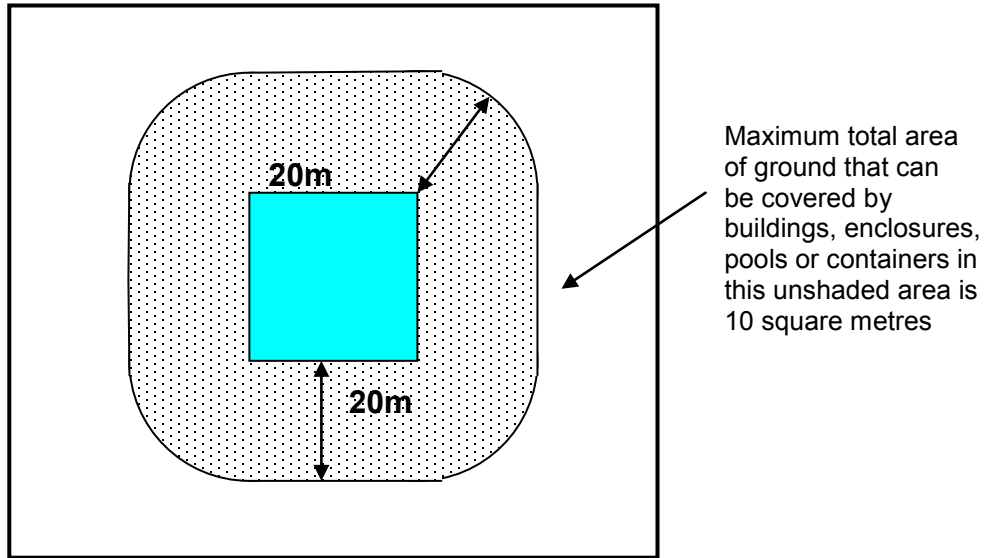

E.3 In the case of any land within the curtilage of the dwellinghouse which is article 2(3) land, development is not permitted by Class E if any part of the building, enclosure, pool or container would be situated on land between a wall forming a side elevation of the dwellinghouse and the boundary of the curtilage of the dwellinghouse

This additional restriction applies for land surrounding a house in National Parks, the Broads, areas of outstanding natural beauty, conservation areas, and within World Heritage Sites. In these areas, buildings, enclosures, pools or containers sited on land between a side wall and the boundary of the land surrounding the house are not permitted development.

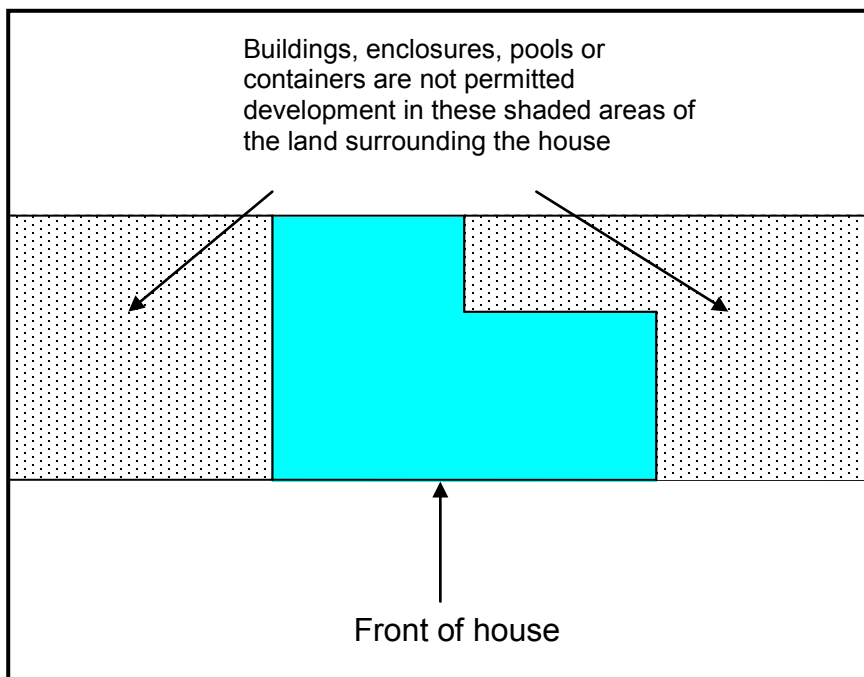

Interpretation of Class E

E.4 For the purposes of Class E, “purpose incidental to the enjoyment of the dwellinghouse as such” includes the keeping of poultry, bees, pet animals, birds or other livestock for the domestic needs or personal enjoyment of the occupants of the dwellinghouse

Other Classes under Part 1

Class F – hard surfaces

This provides permitted development rights within the curtilage of a house for -

- (a) ***the provision of a hard surface for any purpose incidental to the enjoyment of the dwellinghouse as such or***
- (b) ***the replacement in whole or in part of such a surface***

Development is not permitted by Class F if permission to use the dwellinghouse as a dwellinghouse has been granted only by virtue of Class M, N, P, PA, or Q of Part 2 of this Schedule (change of use)

Conditions

F.1 Development is permitted by Class F subject to the condition that where -

- (a) ***the hard surface would be situated on land between a wall forming the principal elevation of the dwellinghouse and a highway, and***
- (b) ***the area of ground covered by the hard surface, or the area of hard surface replaced, would exceed 5 square metres,***

either the hard surface shall be made of porous materials, or provision shall be made to direct run-off water from the hard surface to a permeable or porous area or surface within the curtilage of the dwellinghouse

The Department for Communities and Local Government has produced separate guidance on permeable paving. This can be found at:

https://www.gov.uk/government/uploads/system/uploads/attachment_data/file/7728/paving_frontgardens.pdf

Class G – chimney, flues etc

This provides permitted development rights for the installation, alteration or replacement of a chimney, flue or soil and vent pipe on a dwellinghouse.

G.1 Development is not permitted by Class G if -

- a) permission to use the dwellinghouse as a dwellinghouse has been granted only by virtue of Class M, N, P, PA or Q of Part 2 of this Schedule (change of use)***
- (b) the height of the chimney, flue or soil and vent pipe would exceed the highest part of the roof by 1 metre or more or***
- (c) in the case of a dwellinghouse on article 2(3) land, the chimney, flue or soil and vent pipe would be installed on a wall or roof slope which-***
 - (i) fronts a highway, and***
 - (ii) forms either the principal elevation or a side elevation of the dwellinghouse.***

Guidance on the terms 'highest part of the roof', 'fronts a highway' and 'principal' and 'side' elevations can be found in the 'General Issues' section and under Class A.

Class H – microwave antenna

This provides permitted development rights for the installation, alteration or replacement of a microwave antenna, such as a satellite dish, on a house or within the curtilage of a house.

H.1 Development is not permitted by Class H if -

- a) permission to use the dwellinghouse as a dwellinghouse has been granted only by virtue of Class M, N, P, PA or Q of Part 2 of this Schedule (change of use)***
- (b) it would result in the presence on the dwellinghouse or within its curtilage of-***
 - (i) more than 2 antennas;***
 - (ii) a single antenna exceeding 1 metre in length;***
 - (iii) 2 antennas which do not meet the relevant size criteria;***
 - (iv) an antenna installed on a chimney, where the length of the antenna would exceed 0.6 metres;***
 - (v) an antenna installed on a chimney, where the antenna would protrude above the chimney; or***
 - (vi) an antenna with a cubic capacity in excess of 35 litres***
- (c) in the case of an antenna to be installed on a roof without a chimney, the highest part of the antenna would be higher than the highest part of the roof***
- (d) in the case of an antenna to be installed on a roof with a chimney, the highest part of the antenna would be higher than the highest part of the chimney, or 0.6 metres measured from the highest part of the ridge tiles of the roof, whichever is the lower or***
- (e) in the case of article 2(3) land, it would consist of the installation of an antenna -***
 - (i) on a chimney, wall or roof slope which faces onto, and is visible from, a highway;***
 - (ii) in the Broads, on a chimney, wall or roof slope which faces onto, and is visible from, a waterway; or***
 - (iii) on a building which exceeds 15 metres in height***

Conditions

H.2 Development is permitted by Class H subject to the following conditions -

- (a) an antenna installed on a building shall, so far as practicable, be sited so as to minimise its effect on the external appearance of the building and**
- (b) an antenna no longer needed for reception or transmission purposes shall be removed as soon as reasonably practicable.**

Interpretation of Class H

H.3 For the purposes of Class H –

- (a) the relevant size criteria for the purposes of paragraph H.1(b)(iii) are that –**
 - (i) only one of the antennas may exceed 0.6 metres in length; and**
 - (ii) any antenna which exceeds 0.6 metres in length must not exceed 1 metre in length.**
- (b) the length of the antenna is to be measured in any linear direction, and shall exclude any projecting feed element, reinforcing rim, mounting or brackets.**

Guidance on the 'highest part of the roof' is covered under Class A (c) (see page 11).